



Berkshire

ENGINEERED CLEAN

CONTAMINATION CONTROL

PRODUCT
CATALOG

CLEANROOMS | ASEPTIC PROCESSING | CONTROLLED ENVIRONMENTS | CLEAN MANUFACTURING



AEROSPACE & DEFENSE

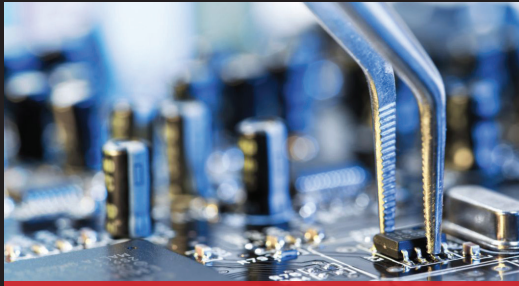

MICROELECTRONICS



AUTOMOTIVE

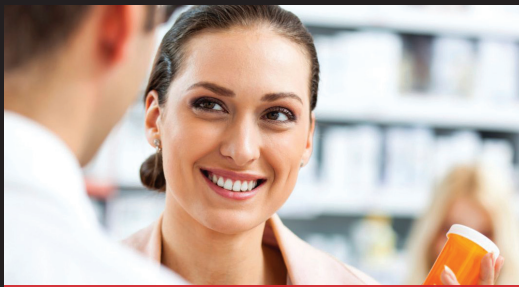

PHARMACEUTICAL

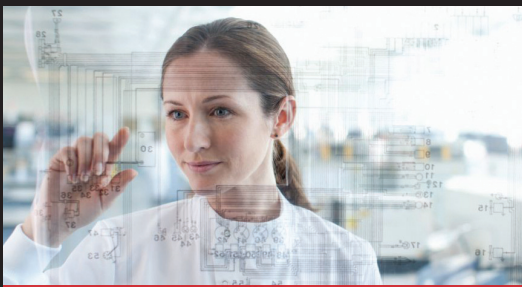

OPTICS



HEALTHCARE



PRINT



MEDICAL DEVICE



UNIVERSITY / RESEARCH



FOOD & BEVERAGE

Berkshire
ENGINEERED CLEAN

BERKSHIRE.COM

TABLE OF CONTENTS

Berkshire Introduction	4
Cleanroom Fundamentals	5
Wiper Substrate and Technology Guide	6 - 8
Dry Wipers Selection Guide	
Knitted Wipers	9 - 12
Nonwoven Wipers	13 - 15
Specialty Wipers	15 - 16
SatPax® Presaturated Wipers Guide	17 - 20
Sterile and Gamma Irradiated Products	21 - 23
Choice® Products	24 - 29
Pro-Wipe® Industrial Wipers	30
BCR® Documentation Systems	31 - 32
BCR® Glove Liners	33
BCR® Face Masks	34
Lab-Tips® Swabs	35 - 40
Mop Systems & Accessories	41 - 48
BCR® Socks and CleanPath™ Adhesive Mats	49
BCR® DuoClean™ - Advanced Cleaning System Dry-To-Wet Technology	50
Low Endotoxin Wipers	51
Disinfectants	52 - 55

DID YOU KNOW?
 This catalog contains blocks of bonus information throughout.

Explore more tech tips and resources here:



The Americas

E-Mail: info@berkshire.com
 Website: www.berkshire.com
www.berkshire.mx

Europe

E-Mail: enquiries@berkshire.uk.com
 Website: www.berkshire.com.de
www.berkshiresalleblanche.fr
www.berkshire.uk.com
www.berkshire.com.es

North Asia

E-Mail: master@berkshire.co.jp
 Website: www.berkshire.co.jp

Southeast Asia

E-mail: enquiries@berkshire.com.sg
 Website: www.berkshire.com.cn
www.berkshire.com.sg



DRIVING THE TECHNOLOGY OF **CONTAMINATION CONTROL**

BECAUSE THE SMALLEST MEASURE CAN MAKE THE BIGGEST DIFFERENCE

Berkshire is the global contamination control leader for clean room and controlled environment consumable products. We provide customers with technically advanced materials aimed at application specific performance solutions. For over 50 years Berkshire has understood and delivered world class manufacturing, reliable supply chain, the highest standards of quality, and technically advanced products.



WHY BERKSHIRE? Engineered Clean

- 1 Quality Programs:**
ISO9001 Certified
SPC
CAPA system
FMEAs
IQ, OQ, PQ

Results:
Superior level of quality, consistency, traceability - the world's cleanest and trusted contamination control products
- 2 How do you determine if your cleanroom supplies are right for your processes?**

Berkshire conducts facility audits that will result in an objective set of observations and recommendations resulting in improved processes and lower TCOO.
- 3 Global Support**



Documentation
Certificates of Sterility
Certificates of Irradiation
Certificates of Conformance
Certificates of Analysis
Safety Data Sheets
Product Information Sheets
Instructional Posters

People - Training
Customer Service Representatives
Contamination Control Specialists
Videos
Chat
Onsite Support
- 4 Innovation**



Advanced Wiper Technology: Duoclean™ CapSure® - IONX®

CLEANROOM CONTAMINATION FUNDAMENTALS

WHAT YOU CAN'T SEE CAN HURT YOU

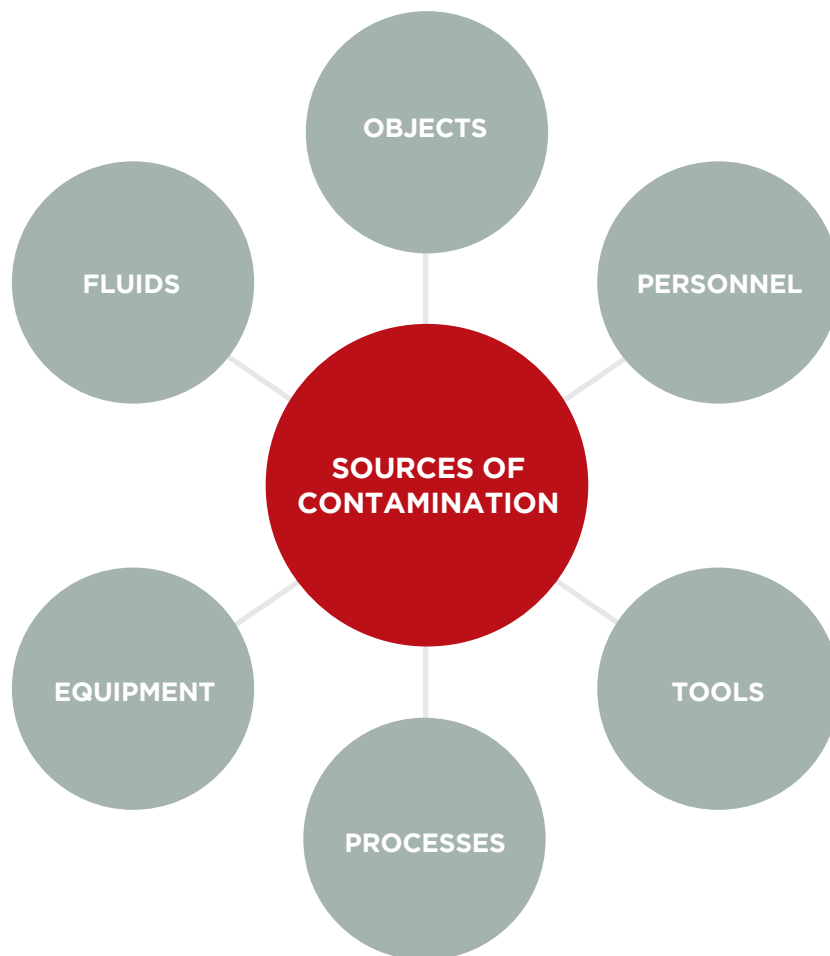

WHAT CAN YOU DO?

Follow a validated cleaning protocol with written SOPs

Choose and use qualified wipers and other cleanroom cleaning supplies

INVISIBLE & VISIBLE CONTAMINATION

SKIN PARTICLES

FIBERS

DUST

GREASE

BACTERIA

VIRUSES

METALS

FUNGI

NVRS

IONS

FILMS

REMEMBER

Inappropriate cleanroom supplies can be a source of contamination, not a solution for controlling contamination

WIPER TEST METHODS

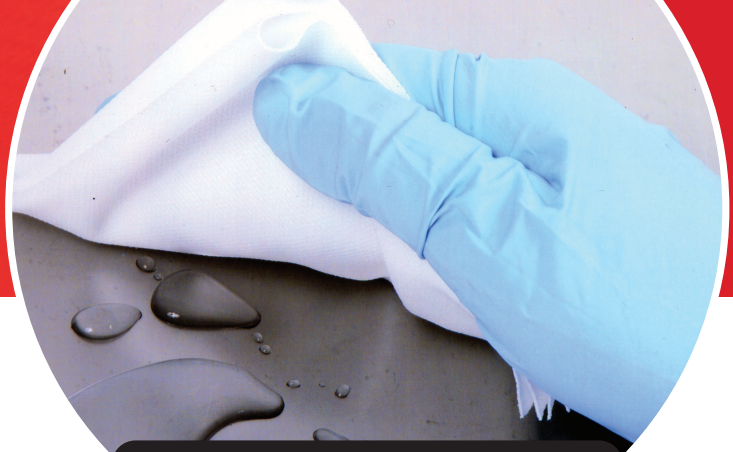

SKU specific test results can be found on Product Information Sheets located at Berkshire.com/shop.html

CLEANLINESS

Fibers

A wiper is “washed” in water using a biaxial shaker for five minutes. The fibers released into the water are filtered onto a membrane and counted microscopically. The results are expressed as fibers \geq 100Qm per square centimeter of wiper. [IEST-RP. CC004.3, Section 6.1.3/6.2.2]

A wiper is “washed” in water using an orbital shaker for five minutes. The fibers released into the water are filtered onto a membrane and counted microscopically. The results are expressed as fibers \geq 100Qm per square centimeter of wiper. [IEST-RP. CC004.4, Section 7.1.3/7.2.2]

Particles

A wiper is “washed” in water using a biaxial shaker for five minutes. A liquid-borne particle counter then tallies the particles released into the water. By dividing the total number of particles released by the area of the wiper, the results are expressed as particles \geq 0.5Qm per square centimeter of wiper. [IEST-RP.CC004.3, Section 6.1.3 / Section 6.2.1]

A wiper is “washed” in water using an orbital shaker for five minutes. A liquid-borne particle counter then tallies the particles released into the water. By dividing the total number of particles released by the area of the wiper, the results are expressed as particles \geq 0.5Qm per square centimeter of wiper. [IEST-RP.CC004.4, Section 7.1.3 / Section 7.2.1]

Airborne Particle/Helmke Drum Test

Under controlled conditions, ten wipers are tumbled in a rotating drum to release particles from the wiper fabric. An airborne particle counter counts released particles and results are expressed as the number of particles per wiper per cubic foot of air sampled. (IEST-RP-CC003.4 Section B2.5)

SORBENCY

Sorbency

A sample piece of material is saturated with as much fluid as it can hold. After one minute, the material is weighed, and results are expressed in millimeters of fluid per square meter. (IEST-RP.CC004.3, Section 8.1 - modified)

Efficiency

This calculation indicates how well a material absorbs, relative to others. Results, expressed in millimeters of liquid per gram of material, assist in comparing one raw material with another.

Rate

This test is a measurement of the time it takes a wiper to absorb a liquid. Results are expressed in seconds. (IEST-RP. CC004.3, Section 8.2 - modified)

PURITY

Non-Volatile Residue

Berkshire generates non-volatile data using both deionized water and 2-Propanol. Results are expressed in grams of extractables per square meter of wiper, which is a useful guide to relative purity of wipers. (IEST-RP.CC004.3, Section 7.1.2)

Metallic Ions

Ions are extracted in deionized water and quantitatively analyzed by Ion Chromatography. Results are stated in parts per million (ppm). (IEST-RP. CC004.3, Section 7.2.2.)

Attribute		Units	Value	Test Method
Basis Weight		g/m ²	134	TAPPI T-410
Caliper		μ m	506	TAPPI T-411
Fibers	\geq 100 μ m	fibers/cm ²	0.017	IEST-RP.CC004.3, Sec 6.1.3 / Sec 6.2.2
Particles	\geq 0.5 μ m	x10 ³ /cm ²	0.57	IEST-RP.CC004.3, Sec 6.1.4 / Sec 6.2.1
Sorbency	Capacity	mL/m ²	371	IEST-RP.CC004.3, Sec 8.1 modified /Sec 8.2 modified
	Efficiency	mL/g	2.8	
	Rate	seconds	1	
Non-Volatile Residue	DI Water	g/m ²	0.0032	IEST-RP.CC004.3, Sec 7.1.2
	IPA	g/m ²	0.011	
Ions	Na+	ppm	0.0059	IEST-RP.CC004.3, Sec 7.2.2
	K+	ppm	0.00089	
	Ca++	ppm	0.0070	
	Mg++	ppm	0.00013	
	Cl-	ppm	0.011	

CHOOSE YOUR WIPER SUBSTRATE

NON-STANDARD OPTIONS AVAILABLE

new substrate, special size, packaging configuration, and saturation level

NONWOVENS

ADVANTAGES

Natural and synthetic
Good strength
More absorbent than knitted
Very consistent
Works well with bleaches, phenols, quaternary ammonium compounds
Less expensive than knitted

CONSIDERATIONS

Higher levels of fiber and particle contamination
Poor in abrasive conditions
Cannot be laundered

BERKSHIRE OPTIONS

55% cellulose/45% polyester	58% polyester/42% lyocell	50% rayon/50% polyester
100% cotton	100% polypropylene	63% abaca/37% softwood
100% polyester	60% polypropylene/	100% manila hemp
45% cellulose/55% polyester	40% cellulose	70% rayon/30% cellulose
60% cellulose/40% polyester	100% polyurethane foam	

KNITTED/ LAUNDERED/ SEALED EDGE

ADVANTAGES

Tubular/sealed edge means low particle and fibers
Typically nonabrasive
Extremely pure
Durability better than nonwovens
Absorbent
Works well with bleaches, phenols, quaternary ammonium compounds
Low NVRs and ionic levels

CONSIDERATIONS

Laundered sealed edge wipers are more expensive.
Not as absorbent as nonwovens

DID YOU KNOW?

Nylon microfiber has an incredibly soft hand

BERKSHIRE OPTIONS

100% continuous filament polyester	70% polyester/30% nylon microfiber
100% polyester microfiber	80% polyester/20% nylon microfiber

KNITTED/ LAUNDERED/ UNSEALED EDGE

ADVANTAGES

Particle, fiber levels of laundered knits are lower than nonwovens
Typically nonabrasive
Extremely pure
Durability better than nonwovens
Absorbent
Works well with bleaches, phenols, quaternary ammonium compounds
Low NVRs and ionic levels

CONSIDERATIONS

Laundered wipers are more expensive
Higher in fibers than sealed edge version
Not as absorbent as nonwovens

BERKSHIRE OPTIONS

100% continuous filament polyester

A breakthrough patented wiper technology from Berkshire, CapSure® features an innovative surface treatment process that enables wipers to **capture and retain** more contaminant particles, providing a more effective wipe and reducing the risk of recontamination.

CAPSURE® - LP EDGE

4-sided sealed border

- Increased durability
- Minimizes fiber & particle release during use

Patented surface treatment

- Captures and retains particle contamination

Made from the ValuSeal® - LP substrate

- Critically low particles, fibers, ions and extractables
- Combination of weight and caliper provide an excellent hand for cleaning rough surfaces

CapSure® Performance Comparison

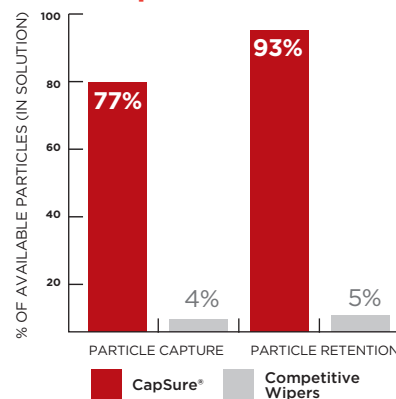

CAPSURE®



SEE OUR
PRODUCT
DEMO VIDEO



SEE OUR
PRODUCT
DEMO VIDEO

BCR® DUOCLEAN™

BCR® DuoClean™ is an Advanced Cleaning System with a dual action line of wipes and chemistries** featuring our patent pending burstable dry-to-wet pouch.

- Wipes and chemistry are activated at point of use
- Easy repacking of contaminated or unused wipes with the peel and reseal pack
- Use the 15 wipe pack the same shift/session
- 3% & 6% hydrogen peroxide with DI H₂O
- 0.525% sodium hypochlorite with DI H₂O

**The CDC and OSHA recognizes sodium hypochlorite and hydrogen peroxide for surface disinfection.

VALUSEAL® IONX®

IonX® - An advanced proprietary ISO Class 4 cleanroom laundry process.

- Ultra-low levels of ionic extractables and leachables

Laser sealed edges

- Minimizes fiber & particle release during use

Lightweight substrate design

- Reduces actual cost in use compared to heavier weight wipers

VALUSEAL® IONX®

ADVANCED WIPER TECHNOLOGY

DRY WIPER SELECTION GUIDE

1 EXCELLENT 2 GOOD 3 FAIR 4 NR

KNITTED WIPERS - LOT TO LOT TRACEABILITY - AUTOCLAVABLE

ISO CLASS 3-5 | CLEANROOM CLASS 1-100 | EU GRADE B/C/D

PRODUCT/SUBSTRATE	STERILE OPTION	ABSORBENCY	ABRASION RESISTANCE	SENSITIVE SURFACES	LOW-LINTING	SOLVENT COMPATIBLE
CAPSURE®-LP Edge 100% continuous filament polyester		1	1	1	1	1
CAPSURE®-LP 100% continuous filament polyester		1	1	1	1	1
CAPSURE®-VP 100% continuous filament polyester		1	1	1	1	1
MICROSEAL® 1200 100% continuous filament polyester	•	2	1	1	1	1
MICROSEAL® Antistatic 100% continuous filament polyester		2	1	1	1	1
MICROSEAL® LI 100% continuous filament polyester		2	1	1	1	1
MICROSEAL SUPERSORB® 100% continuous filament polyester		1	1	1	1	1
MICROSEAL® VP 100% continuous filament polyester	•	2	1	1	1	1
ULTRA-SEAL® 3000 100% continuous filament polyester	•	1	1	1	1	1
VALUSEAL® 1500 100% continuous filament polyester		2	1	1	1	1
VALUSEAL-HA® 100% continuous filament polyester		2	1	1	1	1
VALUSEAL-IONX® 100% continuous filament polyester		2	1	1	1	1
VALUSEAL®-LP 100% continuous filament polyester		2	1	1	1	1

ISO CLASS 4-5 | CLEANROOM CLASS 10-100 | EU GRADE B/C/D

PRODUCT/SUBSTRATE	STERILE OPTION	ABSORBENCY	ABRASION RESISTANCE	SENSITIVE SURFACES	LOW-LINTING	SOLVENT COMPATIBLE
MICROPOLX® 1100 100% polyester microfiber		2	1	1	1	1
MICROPOLX® 2750 70% polyester/30% nylon microfiber		2	1	1	1	1
MICROPOLX® 4000-HP 80% polyester/20% nylon microfiber		2	1	1	1	1
SUPER POLX® 1200 100% continuous filament polyester	•	2	1	1	1	1
SUPER POLX® 1500 100% continuous filament polyester		2	1	1	1	1

ISO CLASS 5-8 | CLEANROOM CLASS 100-100,000 | EU GRADE B/C/D

PRODUCT/SUBSTRATE	STERILE OPTION	ABSORBENCY	ABRASION RESISTANCE	SENSITIVE SURFACES	LOW-LINTING	SOLVENT COMPATIBLE
POLX® 1200 100% continuous filament polyester		2	1	1	2	1

KNITTED WIPERS - LOT TO LOT TRACEABILITY - AUTOCLAVABLE

ISO CLASS 3-5

CLEANROOM CLASS 1-100 | EU GRADE B/C/D

CapSure®-LP Edge

100% continuous filament polyester knit

CapSure®-LP Edge wiper features four sealed-edge sides and is specially engineered for superior surface cleaning.

SKU	SIZE	SHEETS/PACK	PACKS/CASE
CPLPE.0909.8	9x9" (23x23cm)	150	8
CPLPE.0909B.8	9x9" (23x23cm)	150 (BULK)	8

Sealed Border Edge, Cleanroom Laundered

CapSure®-LP

100% continuous filament polyester knit

CapSure®-LP wiper with the breakthrough CapSure® patented surface treatment technology

SKU	SIZE	SHEETS/PACK	PACKS/CASE
CPSLP.0708B.8	7x8" (18x20cm)	300 (BULK)	8
CPSLP.0909.8	9x9" (23x23cm)	150	8
CPSLP.0909B.8	9x9" (23x23cm)	150 (BULK)	8
CPSLP.1212.14	12x12" (30x30cm)	75	14
CPSLP.1212B.14	12x12" (30x30cm)	75 (BULK)	14

Sealed Edge, Cleanroom Laundered

CapSure®-VP

100% continuous filament polyester knit

Lightweight tightly knitted MicroSeal®-VP with the breakthrough CapSure® surface treatment technology

SKU	SIZE	SHEETS/PACK	PACKS/CASE
CPSVP.0708B.8	7x8" (18x20cm)	300 (BULK)	8
CPSVP.0909.8	9x9" (23x23cm)	150	8
CPSVP.0909B.8	9x9" (23x23cm)	150 (BULK)	8
CPSVP.1212.14	12x12" (30x30cm)	75	14
CPSVP.1212B.14	12x12" (30x30cm)	75 (BULK)	14

Sealed Edge, Cleanroom Laundered

MicroSeal® 1200

100% continuous filament polyester knit

MicroSeal® 1200 is a highly absorbent versatile general purpose wiper with an excellent hand for cleaning rough surfaces

SKU	SIZE	SHEETS/PACK	PACKS/CASE
MS1200.0404B.10	4x4" (10x10cm)	600 (BULK)	10
MS1200.0909.8	9x9" (23x23cm)	100	8
MS1200.0909B.8	9x9" (23x23cm)	100 (BULK)	8
MS1200.1212.6	12x12" (30x30cm)	100	6

Sealed Edge, Cleanroom Laundered

MicroSeal® Antistatic

100% continuous filament polyester knit

MicroSeal® Antistatic is manufactured with antistatic fiber which attracts and dissipates static charges.

SKU	SIZE	SHEETS/PACK	PACKS/CASE
MSNW090910	9x9" (23x23cm)	150	10

Sealed Edge, Cleanroom Laundered

MicroSeal® LI

100% continuous filament polyester

A proprietary ISO Class 4 cleanroom laundry process helps ensure ultra low NVR and ionic contaminate levels.

SKU	SIZE	SHEETS/PACK	PACKS/CASE
MSLI090910	9x9" (23x23cm)	150	10

Sealed Edge, Cleanroom Laundered

MicroSeal SuperSorb®

100% continuous filament polyester knit

MicroSeal SuperSorb® 2-ply construction laundry process helps make this the most absorbent polyester wiper available

SKU	SIZE	SHEETS/PACK	PACKS/CASE
MSSS.0909.8	9x9" (23x23cm)	100	8
MSSS.1212.12	12x12" (30x30cm)	50	12

Sealed Edge, Cleanroom Laundered

MicroSeal SuperSorb® LITE

100% continuous filament polyester knit

MicroSeal SuperSorb® LITE is a lightweight version of the highly absorbent MicroSeal SuperSorb®

SKU	SIZE	SHEETS/PACK	PACKS/CASE
SSLT.0909.14	9x9" (23x23cm)	100	14
SSLT.0909B.14	9x9" (23x23cm)	100 (BULK)	14
SSLT.1212.16	12x12" (30x30cm)	50	16
SSLT.1212B.16	12x12" (30x30cm)	50 (BULK)	16

Sealed Edge, Cleanroom Laundered

MicroSeal®-VP

100% continuous filament polyester knit

MicroSeal®-VP is a lightweight wiper with a tightly knit material design that reduces the actual cost in use compared to heavier weight products and minimizes abrasion of components.

SKU	SIZE	SHEETS/PACK	PACKS/CASE
MSPV.0708B.8	7x8" (18x20cm)	300 (BULK)	8
MSPV.0909.8	9x9" (23x23cm)	150	8
MSPV.0909B.8	9x9" (23x23cm)	150 (BULK)	8
MSPV.1212.14	12x12" (30x30cm)	75	14
MSPV.1212B.14	12x12" (30x30cm)	75 (BULK)	14
GWVPST25*	12x12" (30x30cm)	20	25
GWVPST0940*	9x9" (23x23cm)	20	40

Sealed Edge, Cleanroom Laundered

Ultra-Seal® 3000

100% continuous filament polyester knit

Ultra-Seal® 3000 is a 2-ply pinsonic tubular wiper, constructed using a patented sealed edge process resulting in reduced fiber generation and superior absorbency

SKU	SIZE	SHEETS/PACK	PACKS/CASE
US3000.0909.8	9x9" (23x23cm)	100	8
US3000.1212.6	12x12" (30x30cm)	100	6
GW300.ST.25*	12x12" (30x30cm)	10	25

Sealed Border Edge, Cleanroom Laundered



ValuSeal® 1500

100% continuous filament polyester knit

Lightweight, high absorbency material design reduces actual cost in use compared to heavier weight products

SKU	SIZE	SHEETS/PACK	PACKS/CASE
VS1500.0909.8	9x9" (23x23cm)	150	8
VS1500.0909B.8	9x9" (23x23cm)	150 (BULK)	8

Sealed Edge, Cleanroom Laundered

ValuSeal-HA®

100% continuous filament polyester knit

Lightweight and absorbent construction with strong tear and abrasion resistance

SKU	SIZE	SHEETS/PACK	PACKS/CASE
VSHA.0909.8	9x9" (23x23cm)	150	8
VSHA.0909B.8	9x9" (23x23cm)	150 (BULK)	8
VSHA.1212.14	12x12" (30x30cm)	75	14
VSHA.1212B.14	12x12" (30x30cm)	75 (BULK)	14

Sealed Edge, Cleanroom Laundered

ValuSeal® IonX®

100% continuous filament polyester knit

ValuSeal® IonX® is manufactured using a proprietary ISO Class 4 cleanroom laundry process ensuring ultra-low NVR and ionic contamination levels.

SKU	SIZE	SHEETS/PACK	PACKS/CASE
VSI.0708B.14	7x8" (18x20cm)	150 (BULK)	14
VSI.0909.14	9x9" (23x23cm)	150	14
VSI.0909B.14	9x9" (23x23cm)	150 (BULK)	14

Sealed Edge, Cleanroom Laundered

ValuSeal®-LP

100% continuous filament polyester knit

Critically low particles, fibers, ions and extractables

SKU	SIZE	SHEETS/PACK	PACKS/CASE
VSLP.0909.8	9x9" (23x23cm)	150	8
VSLP.0909B.8	9x9" (23x23cm)	150 (BULK)	8
VSLP.1212.14	12x12" (30x30cm)	75	14
VSLP.1212B.14	12x12" (30x30cm)	75 (BULK)	14

Sealed Edge, Cleanroom Laundered

BCR® Glove Liners

Page 32

Glove liners enhance operator comfort by reducing perspiration and contact/heat dermatitis associated with wearing latex and nitrile gloves.

KNITTED WIPERS - LOT TO LOT TRACEABILITY - AUTOCLAVABLE

ISO CLASS 4-5

CLEANROOM CLASS 10-100 | EU GRADE B/C/D

MicroPolx® 1100

100% polyester microfiber

MicroPolx® 1100 has microfiber yarn with 3 times the yarn surface area of standard polyester cleanroom wipers. Its soft smooth surface is suitable for cleaning sensitive or scratch prone surfaces.

SKU	SIZE	SHEETS/PACK	PACKS/CASE
MP1100090914	9x9" (23x23cm)	150	14
MP1100121210	12X12" (30X30cm)	150	10

Sealed Edge, Cleanroom Laundered

MicroPolx® 2750

70% polyester/30% nylon microfiber

MicroPolx® 2750 is manufactured with ultrafine microfiber yarn with wedge shaped fiber cross sections that lift, entrap and remove particulates from critical surfaces. Soft hand and non-abrasive ultrasonic sealed edge are excellent for sensitive or scratch prone surfaces.

SKU	SIZE	SHEETS/PACK	PACKS/CASE
MPX2750.0909.10	9x9" (23x23cm)	100	10

Sealed Edge, Cleanroom Laundered

MicroPolx® 4000-HP

80% polyester/20% nylon microfiber

MicroPolx® 4000-HP removes oily soils with little or no solvent required. The wiper's high fiber surface minimizes the need for potentially harmful solvents.

SKU	SIZE	SHEETS/PACK	PACKS/CASE
MP4000HP060640	6x6" (15x15cm)	25	40
MP4000HP090910	9x9" (23X23cm)	50	10

Sealed Edge, Cleanroom Laundered

Super Polx® 1200

100% continuous filament polyester knit

Super Polx® 1200 absorbs three times its own weight and is durable for abrasive wiping.

SKU	SIZE	SHEETS/PACK	PACKS/CASE
S1200.0404.10	4x4" (10x10cm)	600 (BULK)	10
S1200.0606.9	6x6" (15x15cm)	300	9
S1200.0708B.8	7x8" (18x20cm)	300 (BULK)	8
S1200.0909.8	9x9" (23x23cm)	150	8
S1200.0909B.8	9x9" (23x23cm)	150 (BULK)	8
S1200.1212.14	12x12" (30x30cm)	75	14
S1200.1212B.14	12x12" (30x30cm)	75 (BULK)	14
GW120ST0940*	9x9" (23x23cm)	20	40
GW120.ST.15*	12x12" (30x30cm)	20	15

Knife Cut, Cleanroom Laundered

Super Polx® 1500

100% continuous filament polyester knit

Super Polx® 1500 absorbs two times its own weight and is lightweight and economical.

SKU	SIZE	SHEETS/PACK	PACKS/CASE
S1500.0909.8	9x9" (23x23cm)	150	8
S1500.0909B.6	9x9" (23x23cm)	150 (BULK)	6

Knife Cut, Cleanroom Laundered

ISO CLASS 5-8

CLEANROOM CLASS 100-100,000 | EU GRADE B/C/D

Polx® 1200

100% continuous filament polyester knit

Polx® 1200 bridges the gap between more expensive laundered wipers and lower cost less critical nonwovens.

SKU	SIZE	SHEETS/PACK	PACKS/CASE
P1200.0404.18	4x4" (10x10cm)	150	18
P1200.0909.8	9x9" (23x23cm)	150	8
P1200.0909B.1	9x9" (23x23cm)	1200 (BULK)	
P1200.1212.14	12x12" (30x30cm)	75	14

Knife Cut Edge, Unlaundered



NONWOVEN WIPERS - LOT TO LOT TRACEABILITY - AUTOCLAVABLE

ISO CLASS 5-8

CLEANROOM CLASS 100-100,000 | EU GRADE B/C/D

1	EXCELLENT	3	FAIR
2	GOOD	4	NR

PRODUCT/SUBSTRATE	STERILE OPTION	ABSORBENCY	ABRASION RESISTANCE	SENSITIVE SURFACES	LOW-LINTING	SOLVENT COMPATIBLE
BLUESORB® 750 55% cellulose/45% polyester		1	2	2	2	2
DURX® 570 55% cellulose/45% polyester		1	2	2	2	2
DURX® 670 55% cellulose/45% polyester	•	1	2	2	2	2
DURX® 770 55% cellulose/45% polyester		1	2	2	2	2
ECOCLEAN® 35 100% cotton		1	2	2	2	2
ECOCLEAN® 60 100% cotton		1	2	2	2	2
MICROFIRST® 45% cellulose/55% polyester		1	2	2	2	2
MICROFIRST® LP 58% polyester/42% lyocell		1	1	1	2	2
POLX® NONWOVEN 100% polyester		2	1	1	2	1
PROJX® 700 55% cellulose/45% polyester		1	2	2	2	2
PRO-WIPE® 750 60% polypropylene/40% cellulose		1	2	1	1	2
PRO-WIPE® 880 100% polypropylene		2	2	1	1	1
VALUCLEAN® PLUS 50% rayon/50% polyester (not autoclavable)		1	2	2	2	2

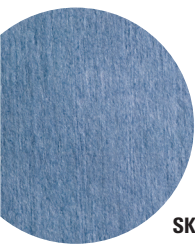

BlueSorb® 750 55% cellulose/45% polyester

BlueSorb® 750's color allows differentiation for guarding against migration into critical areas as well as providing background differentiation for product inspection.

SKU	SIZE	SHEETS/PACK	PACKS/CASE
BS750.0404.40	4x4" (10x10cm)	300	40
BS750.0909.20	9x9" (23x23cm)	300	20
BS750.1212.20	12x12" (30x30cm)	150	20

Blue color, smooth, absorbent and durable

Durx® 570 55% cellulose/45% polyester

Durx® 570 is a lightweight, economical, general purpose wiper that is smooth, highly absorbent and durable

SKU	SIZE	SHEETS/PACK	PACKS/CASE
DR570.0708.36	7x8" (18x20cm)	300	36
DR570.0909.10	9x9" (23x23cm)	300	10
DR570.0909.20	9x9" (23x23cm)	300	20
DR570.1212.10	12x12" (30x30cm)	150	10
DR570.1212.20	12x12" (30x30cm)	150	20

No binders or chemical additives

Durx® 670

55% cellulose/45% polyester

Durx® 670 is an economical general purpose wiper that is smooth, highly absorbent and durable

SKU	SIZE	SHEETS/PACK	PACKS/CASE
DR670.0404.10	4x4" (10x10cm)	1200	10
DR670.0404.40	4x4" (10x10cm)	300	40
DR670.0707.12	7x7" (18x18cm)	300	12
DR670.0707.45	7x7" (18x18cm)	300	45
DR670.0708.36	7x8" (18x20cm)	300	36
DR670.0909.20	9x9" (23x23cm)	300	20
DR670.1212.20	12x12" (30x30cm)	150	20
DR670.1818.10	18x18" (46x46cm)	150	10
GW67ST0980*	9x9" (23x23cm)	20	80
GW67ST25*	12x12" (30x30cm)	20	25
GW67ST60*	12x12" (30x30cm)	5	60

No binders or chemical additives.

Meets AMS 3819, class 2, grade A, Form 1

QPL-BMS-15-5

FDA 21-CFR, Food Contact Compliant

NONWOVEN WIPERS - LOT TO LOT TRACEABILITY - AUTOCLAVABLE

Durx® 770

55% cellulose/45% polyester

Durx® 770 is a treated wiper for applications requiring lower fiber and particle counts than average nonwovens.

SKU	SIZE	SHEETS/PACK	PACKS/CASE
DR770.0404.40	4x4" (10x10cm)	300	40
DR770.0707.45	7x7" (18x18cm)	300	45
DR770.0909.20	9x9" (23x23cm)	300	20
DR770.1212.20	12x12" (30x30cm)	150	20
DR770.1818.10	18x18" (46x46cm)	150	10

Enhanced with an ultra low particle and fiber treatment

EcoClean® 35

100% nonwoven cotton

EcoClean® 35 is 1/4 folded to fit the hand and promote proper wiping technique. The aperatured surface aids in particle pick up and entrapment. Excellent gauze replacement.

SKU	SIZE	SHEETS/PACK	PACKS/CASE
ECW35.0505.30	10x10" (1/4 folded)	100	30

FDA 21 CFR, Food Contact Compliant,

EcoClean® 60

100% nonwoven cotton

EcoClean® 60 is excellent for sensitive surfaces and high temperature applications. It has high strength and resists build up of static charge.

SKU	SIZE	SHEETS/PACK	PACKS/CASE
ECW60.0909.20	9x9" (23x23cm)	300	20
ECW60.1212.20	12x12" (30x30cm)	150	20

FDA 21 CFR, Food Contact Compliant,

MicroFirst®

45% cellulose/55% polyester

MicroFirst® is aperatured for increased absorbency and increased surface texture for improved cleaning efficiency.

SKU	SIZE	SHEETS/PACK	PACKS/CASE
MF.0909.20	9x9" (23x23cm)	300	20
MF.1212.20	12x12" (30x30cm)	150	20

Durable with high wet strength

MicroFirst® LP

58% polyester/42% lyocell

MicroFirst® LP has the highest combination of purity and absorbency available in nonwovens. It is soft and excellent for wiping delicate surfaces. It is the cleanest nonwoven option.

SKU	SIZE	SHEETS/PACK	PACKS/CASE
MFLP.0909.12	9x9" (23x23cm)	150	12

No binders or chemical additives

PolX® Nonwoven

100% Polyester

Polx® is an extremely soft and pliable wiper ideal for many types of sensitive surfaces. It is an exceptional choice for streak-free cleaning.

SKU	SIZE	SHEETS/PACK	PACKS/CASE
PNW040440	4x4" (10x10cm)	250	40
PNW090920	9x9" (23x23cm)	250	20
PNW121220	12x12" (30x30cm)	150	20
GWPNWST1242	12x12" (30x30cm)	25	42

Treated with a proprietary process

ProjX® 700

55% cellulose/45% polyester

ProjX® 700 is a lightweight industrial wiper. It has the excellent combination of synthetic polyester strength and cleanliness with the absorbency characteristics of cellulose.

SKU	SIZE	SHEETS/PACK	PACKS/CASE
PJ700.0909.20	9x9" (23x23cm)	200	20
PJ700.1212.20	12x12" (30x30cm)	150	20

Creped design for increased absorbency

Pro-Wipe® 750

60% polypropylene/40% cellulose

Pro-Wipe® 750 is a multi-layer composite wiper with a cellulose layer thermally bonded between the two polypropylene outer layers, resulting in an extremely durable and pure, solvent resistant industrial wiper with very low particle and fiber generation.

SKU	SIZE	SHEETS/PACK	PACKS/CASE
PW750.0404.20	4x4" (10x10cm)	400	20
PW750.0909.20	9x9" (23x23cm)	150	20
PW750.1212.20	12x12" (30x30cm)	75	20

FDA 21 CFR, Food Contact Compliant

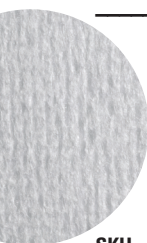
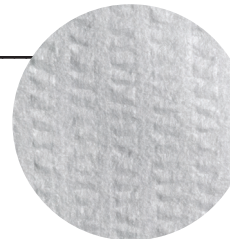

WATCH
ECOCLEAN® 35
VIDEO



NONWOVEN WIPERS - LOT TO LOT TRACEABILITY - AUTOCLAVABLE



Pro-Wipe® 880

100% polypropylene

Pro-Wipe® 880 is composed of multiple layers of polypropylene thermally bonded in a quilted construction. This combination results in exceptional cleanliness, absorbency, and chemical resistance to strong solvents, including acids.

SKU	SIZE	SHEETS/PACK	PACKS/CASE
PW880.0606.48	6x6" (15x15cm)	100	48
PW880.0810.12	8x10" (20x25cm)	100	12
PW880.1212.12	12x12" (30x30cm)	100	12

FDA 21 CFR, Food Contact Compliant

ValuClean® Plus

50% rayon/50% polyester

ValuClean® Plus is a high absorbency wiper compared to typical cellulose/polyester nonwovens. Its soft hand and low fiber shedding performance make it a good choice in critical cleaning applications where economy is important.

SKU	SIZE	SHEETS/PACK	PACKS/CASE
VCLP0707.45	7x7" (18x18cm)	300	45
VCLP0909.20	9x9" (23x23cm)	300	20
VCLP1212.20	12x12" (30x30cm)	150	20

Rayon content for high absorbency (not autoclavable)

SPECIALTY WIPERS - LOT TO LOT TRACEABILITY - AUTOCLAVABLE

ISO CLASS 6-8

CLEANROOM CLASS 1000-100,000 | EU GRADE C/D

1	EXCELLENT	3	FAIR
2	GOOD	4	NR

PRODUCT/SUBSTRATE	STERILE OPTION	ABSORBENCY	ABRASION RESISTANCE	SENSITIVE SURFACES	LOW-LINTING	SOLVENT COMPATIBLE
LABX® 123 is 100% manila hemp		2	3	1	2	2
LABX® 170 80% abaca (manila hemp)/20% wood pulp		2	3	1	2	2
LENSX® 90 70% rayon/30% cellulose		2	3	1	2	2
TWILLX® 1622 100% cotton		1	1	3	3	2

Labx® 123

100% manila hemp

Labx® 123 is a wiper engineered to be lightweight and low linting. It has excellent wet strength.

SKU	SIZE	SHEETS/PACK	PACKS/CASE
LB123.0707.20	7x7" (18x18cm)	1000	20
LB123.0909.60	9x9" (23x23cm)	500	60
LB123.1212.30	12x12" (30x30cm)	500	30

Meets government specification AA-50177, Type 1, Class 5

Labx® 170

80% abaca (manila hemp)/20% wood pulp

Labx® 170 is a cleaner alternative to industrial tissues and wipers. It has excellent wet strength, is low linting and is highly absorbent.

SKU	SIZE	SHEETS/PACK	PACKS/CASE
LB170.0707.28	7x7" (18x18cm)	500	28
LB170.0909.40	9x9" (23x23cm)	500	40
LB170.1212.20	12x12" (30x30cm)	500	20
LB170.1818.10	18x18" (46x46cm)	500	10

Meets government specification AA-50177, Type 1, Class 4

Lensx® 90*

70% rayon/30% manila hemp

Lensx® 90 is a nonabrasive wiper engineered for extreme softness and for use in cleaning delicate surfaces.

SKU	SIZE	SHEETS/PACK	PACKS/CASE
LN90.0406.24	4x6" (10x15cm)	1000	24
LN90.0909.16	9x9" (23x23cm)	1000	16
LN90.1212.4	12x12" (30x30cm)	1000	4
LN9024365	24x36" (61x91cm)	1000	5

Meets government specification AA-50177, Type 1, Class 1

Twillx® 1622

100% woven cotton

Twillx® 1622 is engineered for thermal stability and high heat applications. It is highly sorbent and durable.

SKU	SIZE	SHEETS/PACK	PACKS/CASE
T1622.0909.8	9x9" (23x23cm)	300	8
T1622.1212.4	12x12" (30x30cm)	150	4

Sturdy, durable and highly sorbent

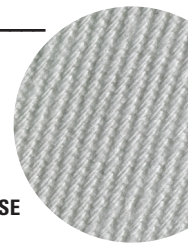



PureSorb®

100% polyurethane foam

PureSorb® is a 100ppi open cell polyester-based polyurethane foam wiper. It is laundered and hydrophilic. The thickness of the wiper is 0.15 inch.



SKU	SIZE	SHEETS/PACK	PACKS/CASE
PS040520	4x5" (10x13cm)	50	20
PS06098	6x9" (15x23cm)	50	8

Extremely pure and clean

DID YOU KNOW?

PureSorb® has an "Easy Open Notch". It is double bagged with an opaque white outer bag that prevents light from reaching the product, preventing discoloration.

WHAT IS A HYDROPHILIC CLEANROOM WIPER?



DOWNLOAD BERKSHIRE'S WIPER CHEMICAL COMPATIBILITY CHART



CHEMICALS	COMPATIBILITY RESPONSE (SEE KEY)	NOTES (SEE ADDITIONAL INFO ON WEBSITE)
Azobisisobutyronitrile (AIBN)	ADVERSE/CALL	Do not use with Polyurethane foam wipers. May cause discoloration.
Benzene	ADVERSE/CALL	Do not use with Polyurethane foam wipers. May cause discoloration.
Bleach (Sodium Hypochlorite)	ADVERSE/CALL	Do not use with Polyurethane foam wipers. May cause discoloration.
Chloroform	ADVERSE/CALL	Do not use with Polyurethane foam wipers. May cause discoloration.
Concentrated Hydrochloric Acid (HCl)	ADVERSE/CALL	Do not use with Polyurethane foam wipers. May cause discoloration.
Concentrated Sulfuric Acid (H2SO4)	ADVERSE/CALL	Do not use with Polyurethane foam wipers. May cause discoloration.
Concentrated Nitric Acid (HNO3)	ADVERSE/CALL	Do not use with Polyurethane foam wipers. May cause discoloration.
Concentrated Phosphoric Acid (H3PO4)	ADVERSE/CALL	Do not use with Polyurethane foam wipers. May cause discoloration.
Concentrated Acetic Acid (CH3COOH)	ADVERSE/CALL	Do not use with Polyurethane foam wipers. May cause discoloration.
Concentrated Ammonia (NH3)	ADVERSE/CALL	Do not use with Polyurethane foam wipers. May cause discoloration.
Concentrated Hydrofluoric Acid (HF)	ADVERSE/CALL	Do not use with Polyurethane foam wipers. May cause discoloration.
Concentrated Peracetic Acid (CH3COOOH)	ADVERSE/CALL	Do not use with Polyurethane foam wipers. May cause discoloration.
Concentrated Hydrogen Peroxide (H2O2)	ADVERSE/CALL	Do not use with Polyurethane foam wipers. May cause discoloration.
Concentrated Sodium Hydroxide (NaOH)	ADVERSE/CALL	Do not use with Polyurethane foam wipers. May cause discoloration.
Concentrated Potassium Hydroxide (KOH)	ADVERSE/CALL	Do not use with Polyurethane foam wipers. May cause discoloration.
Concentrated Sodium Hypochlorite (NaOCl)	ADVERSE/CALL	Do not use with Polyurethane foam wipers. May cause discoloration.
Water	ADVERSE/CALL	Do not use with Polyurethane foam wipers. May cause discoloration.

SATPAX® PRESATURATED WIPERS GUIDE

Sterile pre-wetted wipers have the lot # on each pack with a 3 year shelf life.



ADVANTAGES

Health & Safety - no mixing and storing of hazardous liquids

Contamination - minimize volatile organic compounds (VOCs)

Control - no over-spraying or wetting of surfaces

Consistency - problems associated with under-or over-wetting the wiper are eliminated

Economy - greater cleaning efficiency and cleaning protocol consistency and effectiveness can be obtained

DEFINITIONS

DI (deionized) Water: Water that has had its mineral ions removed, such as cations from sodium, calcium, iron, copper and anions such as chloride and bromide.

WFI (Water for Injection): USP Water for Injection is prepared from water complying with quality attributes of "Drinking Water." Purified by distillation or a purification process that is equivalent or superior to distillation in the removal of chemicals or microorganisms. WFI water is tested and certified to be at or below a certain level of endotoxins.

IPA: Isopropyl alcohol can be produced in several distinct grades. The two most commonly used in pre-wetted wipers are USP and Semiconductor grades. The primary difference between the two grades is the level of purification. Semiconductor grades have much more stringent requirements for metallic content and therefore are much purer in use. USP grade is typically used for sterile products while semiconductor grade is typically used in all other products.

VOCs: Volatile organic compounds (VOCs) are organic chemicals that have a high vapor pressure at ordinary room temperature. Their high vapor pressure results from a low boiling point, which causes large numbers of molecules to evaporate or sublime from the liquid or solid form of the compound and enter the surrounding air.

SatPax® complies with the Global Harmonized System of Classification and Labeling of Chemicals

**"PRE-WETTED WIPERS
OPTIMIZED FOR
APPLICATION-SPECIFIC
CLEANING"**



SATPAX® PRESATURATED WIPERS - LOT TO LOT TRACEABILITY

ISO CLASS 3-5

CLEANROOM CLASS 1-100 | EU GRADE B/C/D

PRODUCT/SUBSTRATE	STERILE OPTION	PRODUCT FAMILY	SEALED BORDER	SEALED EDGE	CUT EDGE	SOLUTION OPTION	CANISTER OPTION
SATPAX® 3000 100% continuous filament polyester		Ultra-Seal® 3000	●			70% IPA/30% DI H ₂ O 9% IPA/91% DI H ₂ O	
SATPAX® MICROSEAL® - VP 100% continuous filament polyester		MicroSeal® -VP		●		70% IPA/30% DI WFI 100% IPA 6% IPA/94% DI H ₂ O	
SATPAX® VALUSEAL® HA-R 100% continuous filament polyester		ValuSeal® -HA		●		70% IPA/30% DI H ₂ O	
SATPAX® VALUSEAL® LP 100% continuous filament polyester		ValuSeal® -LP		●		70% IPA/30% DI H ₂ O	
SATPAX® VALUSEAL® 1500 100% continuous filament polyester	●	ValuSeal® 1500		●		70% IPA/30% DI H ₂ O 6% IPA/94% DI H ₂ O	
Sterile SATPAX® MICROSEAL® 1200 WFI 100% continuous filament polyester		MicroSeal® 1200		●		70% IPA/30% DI WFI	

SatPax® 3000

100% continuous filament polyester

SatPax® 3000 is a 2-ply pinsonic tubular wiper, constructed using a patented sealed edge process resulting in reduced fiber generation. It is available in a consistent 70% IPA/30% DI H₂O and 9% IPA/91% DI H₂O solution.

SKU	SIZE	SHEETS/ PACK	PACKS/ CASE	SAT.	VOC%
SPX3000.001.12	9x9" (23x23cm)	30	12	33%	29%
SPX3000.002.12	9x9" (23x23cm)	30	12	28%	3.2%

Sealed Border Edge, Cleanroom Laundered, Resealable Packaging

SatPax® ValuSeal® HA-R

100% continuous filament polyester

SatPax® ValuSeal® HA-R is presaturated with a consistent 70% IPA/30% DI H₂O solution saturated at a 60% level. The higher saturation level is recommended for solution contact time in the regulated industries.

SKU	SIZE	SHEETS/ PACK	PACKS/ CASE	SAT.	VOC%
SPXHAR.01.8	12x12" (30x30cm)	25	8	65%	45%

Sealed Edge, Cleanroom Laundered, Resealable Packaging

SatPax® ValuSeal® 1500

100% continuous filament polyester

SatPax® ValuSeal® 1500 is a lightweight wiper that is available presaturated with a consistent 70% IPA/30% DI H₂O and 6% IPA/94% DI H₂O solution.

SKU	SIZE	SHEETS/ PACK	PACKS/ CASE	SAT.	VOC%
SPXV1500.001.12	9x9" (23x23cm)	30	12	33%	35%
SPXV1500.004.12	9x9" (23x23cm)	30	12	33%	28%

Sealed Edge, Cleanroom Laundered, Resealable Packaging

SatPax® ValuSeal®-LP

100% continuous filament polyester

SatPax® ValuSeal®-LP is presaturated with a consistent 70% IPA/30% DI H₂O solution. It is critically low in particles, fibers, ions and extractables.

SKU	SIZE	SHEETS/ PACK	PACKS/ CASE	SAT.	VOC%
SPXVSLP.003.12	9x9" (23x23cm)	30	12	80%	23.4%

Sealed Edge, Cleanroom Laundered, Resealable Packaging

Sterile SatPax® MicroSeal® 1200 WFI

100% continuous filament polyester

Sterile SatPax® MicroSeal® 1200 WFI is presaturated with a consistent 70% IPA/30% WFI (Water for Injection) to a high saturation level. It is triple packaged for easy entry into sterile environments. It is gamma irradiated and sterile validated to a 10⁻⁶ Sterility Assurance Level per ANSI/AAMI/ISO guidelines.

SKU	SIZE	SHEETS/ PACK	PACKS/ CASE	SAT.	VOC%
SSPMS015WFI*	12x12" (30x30cm)	50	5	60%	24.4%

Sealed Edge, Cleanroom Laundered, Resealable Packaging

SatPax® MicroSeal® - VP

100% continuous filament polyester

SatPax® MicroSeal® is a lightweight wiper that is available presaturated with a consistent 70% IPA, 6% IPA*, and 100% IPA (CMOS*)

SKU	SIZE	SHEETS/ PACK	PACKS/ CASE	SAT.	VOC%
SPXVP00112	9x9" (23x23cm)	30	12	33%	28%
SPXVPR00112	9x9" (23x23cm)	30	12	60%	38%
SPXMSVP0028**	9x9" (23x23cm)	100	8	45%	54.9%
SPXMSVP0068*	6x9" (15x23cm)	180	8	45%	2.9%
SPXVP.003.6R	9x9" (23x23cm)	150	6	60%	43.7%
SSPVP00124	9x9" (23x23cm)	30	24	47%	39.5%
SSPVP00124	9x9" (23x23cm)	30	24	60%	43.2%

Sealed Edge, Cleanroom Laundered, Resealable Packaging

SATPAX® PRESATURATED WIPERS - LOT TO LOT TRACEABILITY

ISO CLASS 4-5

CLEANROOM CLASS 10-100 | EU GRADE B/C/D

PRODUCT/SUBSTRATE	STERILE OPTION	PRODUCT FAMILY	SEALED BORDER	SEALED EDGE	CUT EDGE	SOLUTION OPTION	CANISTER OPTION
SATPAX® 1200-R 100% continuous filament polyester	●	Super Polx® 1200			●	70% IPA/30% DI H ₂ O	

SatPax® 1200-R

100% continuous filament polyester

SatPax® 1200-R is presaturated with a consistent 70% IPA/30% DI H₂O solution with a higher saturation level for solution contact time in the regulated industries. The sterile version is gamma irradiated and sterile validated to a 10⁻⁶ Sterility Assurance Level per ANSI/AAMI/ISO guidelines.

SKU	SIZE	SHEETS/PACK	PACKS/CASE	SAT.	VOC%
SPX120R.001.12	9x9" (23x23cm)	30	12	60%	40.9%
SSP120000312	9x9" (23x23cm)	30	12	60%	40.9%

Knife Cut Edge, Cleanroom Laundered, Resealable Packaging

ISO CLASS 5-8

CLEANROOM CLASS 100-100,000 | EU GRADE B/C/D

PRODUCT/SUBSTRATE	STERILE OPTION	PRODUCT FAMILY	SEALED BORDER	SEALED EDGE	CUT EDGE	SOLUTION OPTION	CANISTER OPTION
SATPAX® 550 100% polypropylene	●				●	70% IPA/30% DI H ₂ O 100% IPA	
SATPAX® 570 55% cellulose/45% polyester		Durx® 570			●	70% IPA/30% DI H ₂ O	
SATPAX® 670-R 55% cellulose/45% polyester	●	Durx® 670			●	70% IPA/30% DI H ₂ O	
SATPAX® 1000 55% cellulose/45% polyester	●	Durx® 670			●	70% IPA/30% DI H ₂ O 9% IPA/91% DI H ₂ O 6% IPA/94% DI H ₂ O	●
SATPAX® STENCIL CLEANERS 60% cellulose/40% polyester						Zestron Vigon® SC200	
SATPAX® Polx® Nonwoven 100% polyester	●				●	70% IPA/30% DI H ₂ O	

SatPax® 1000

55% cellulose/45% polyester

SKU	SIZE	SHEETS/PACK	PACKS/CASE	SAT.	VOC%
SPX1000.001.12	9x9" (23x23cm)	75	12	45%	40%
SPX1000.011.12	9x9" (23x23cm)	75	12	45%	3.1%
SPX1000.002.12	9x9" (23x23cm)	75	12	45%	4.7%
SPX100001212**	6x9" (15x23cm)	100	12	45%	39.6%
SPXC100000112	6x9" (15x23cm)	100	12	45%	40%
SPXC10000112R	6x9" (15x23cm)	100	12	45%	40%
SPXC100000212	6x9" (15x23cm)	100	12	45%	4.7%
SPXC10000212R	6x9" (15x23cm)	100	12	45%	4.7%
SSP100000124*	9x9" (23x23cm)	30	24	60%	44%

Knife Cut Edge, Resealable Packaging and **Canisters with Refills**

SatPax® 670-R

55% cellulose/45% polyester

SatPax® 670-R is a durable and strong presaturated wiper with a consistent 70% IPA/30% DI H₂O solution with a higher saturation level of 60% for solution contact time in the regulated industries. Meets AMS 3819, Class 2, Grade A, Form 2 - QPL-15-5

SKU	SIZE	SHEETS/PACK	PACKS/CASE	SAT.	VOC%
SPX670R.001.12	9x9" (23x23cm)	75	12	60%	44%
SSP670.001.24*	9x9" (23x23cm)	30	24	60%	44%

Knife Cut Edge, Resealable Packaging

SatPax® 550

100% polypropylene

SatPax® 550 is a lightweight wiper that has very low levels of fibers, particles and ions. It is presaturated with a consistent 70% IPA/30% DI H₂O solution. **100% IPA option**. The sterile version is gamma irradiated and sterile validated to a 10⁻⁶ Sterility Assurance Level per ANSI/AAMI/ISO guidelines.

SKU	SIZE	SHEETS/PACK	PACKS/CASE	SAT.	VOC%
SPX550.001.24	9x11" (23x28cm)	50	24	71%	50.1%
SPX550.003.36	7x11" (18x28cm)	75	36	71%	50%
SPX550.004.24	9x11" (23x28cm)	50	24	57%	47.2%
SPX550.005.36	7x11" (18x28cm)	75	36	57%	47.2%
SPX55000836	7x11" (18x28cm)	75	36	71%	76.1%
SSP55000424*	9x11" (23x28cm)	50	24	62%	48.3%
SSP55000524*	7x11" (18x28cm)	50	24	62%	48.3%

Knife Cut Edge, Resealable Packaging

SATPAX® PRESATURATED WIPERS - LOT TO LOT TRACEABILITY

SatPax® 570

55% cellulose/45% polyester

SatPax® 570 is a lightweight, smooth, and durable presaturated wiper with a consistent 70% IPA/30% DI H₂O solution.

SKU	SIZE	SHEETS/ PACK	PACKS/ CASE	SAT.	VOC%
SPX570.001.24	7x8" (18x20cm)	90	24	45%	41.3%

Knife Cut Edge, Resealable Packaging

SatPax® Stencil Cleaners

60% cellulose/40% polyester

SatPax® Stencil Cleaner wipes with Zestron Vigon® SC200 is a powerful combination of low lint wiping materials and effective stencil chemistry. The wipes quickly remove all types of solder pastes and adhesives used in electronic assembly manufacturing. They are fast drying and odor free. Non-hazmat.

SKU	SIZE	SHEETS/ PACK	PACKS/ CASE	SAT.	VOC%
SPXCHZ0016	6x8" (16X20cm)	150	16	45%	CANISTER
SPXCHZ00116R	6x8" (16X20cm)	150	16	45%	REFILL

Knife Cut Edge, Resealable Packaging

SatPax® Polx® Nonwoven

100% polyester

SatPax® Polx® Nonwoven is an extremely soft and pliable wiper ideal for all types of sensitive surfaces. It is presaturated with a consistent 70% IPA/30% DI H₂O solution.

SKU	SIZE	SHEETS/ PACK	PACKS/ CASE	SAT.	VOC%
SPXPNW00112	9x9" (23x23cm)	75	12	60%	42%

No cellulose components, Resealable Packaging



STERILE AND GAMMA IRRADIATED PRODUCTS

VALIDATE STERILE CLEANROOM WIPERS

- Gamma irradiated and sterile validated to a 10^{ww-6} Sterility Assurance Level (SAL) per ANSI/AAMI/ISO guidelines
- Header bag style
- Lot number of each pack for traceability
- Certificate of Sterility(COS) available on berkshire.com by lot number 24/7

COS Details:

- Expiration Date, Radiation Dosage, Lot Information,
- Meets cGMP requirements for traceability

READ
WHAT ARE VALIDATED
STERILE WIPERS?



STERILE DRY WIPERS

ISO CLASS 3-5

CLEANROOM CLASS 1-100 | EU GRADE A/B/C/D

Gamma Wipe® 300

100% continuous filament polyester knit

Gamma Wipe® 300 is a 2-ply pinsonic tubular wiper, constructed using a patented sealed edge process resulting in reduced fiber generation and superior absorbency. It has been gamma irradiated and sterile validated to a 10⁻⁶ Sterility Assurance Level per ANSI/AAMI/ISO guidelines.

SKU	SIZE	SHEETS/ PACK	PACKS/ CASE
GW300ST25	12x12" (30x30cm)	10	25

Sealed Border Edge, Cleanroom Laundered



Gamma Wipe® VP

100% continuous filament polyester knit

Gamma Wipe® VP is a cleanroom laundered lightweight wiper with a tightly knit material design that reduces the actual cost in use compared to heavier weight products. It has been gamma irradiated and sterile validated to a 10⁻⁶ Sterility Assurance Level per ANSI/AAMI/ISO guidelines.

SKU	SIZE	SHEETS/ PACK	PACKS/ CASE
GWVPST0940	9x9" (23x23cm)	20	40
GWVPST25	12x12" (30x30cm)	20	25

Sealed Edge, Cleanroom Laundered

ISO CLASS 4-5

CLEANROOM CLASS 10-100 | EU GRADE A/B/C/D

Gamma Wipe® 120

100% continuous filament polyester knit

Gamma Wipe® 120 is a knife cut cleanroom laundered wipe, with a soft hand and edge for sensitive surfaces. It has been gamma irradiated and sterile validated to a 10⁻⁶ Sterility Assurance Level per ANSI/AAMI/ISO guidelines.

SKU	SIZE	SHEETS/ PACK	PACKS/ CASE
GW120ST0940	9x9" (23x23cm)	20	40
GW120.ST.15	12x12" (30x30cm)	20	15

Knife Cut, Cleanroom Laundered

ISO CLASS 5-8

CLEANROOM CLASS 100-100,000 | EU GRADE A/B/C/D

Gamma Wipe® 67

55% cellulose/45% polyester

Gamma Wipe® 67 is an economical wipe that is smooth, highly absorbent and durable. It has been gamma irradiated and sterile validated to a 10⁻⁶ Sterility Assurance Level per ANSI/AAMI/ISO guidelines.

SKU	SIZE	SHEETS/ PACK	PACKS/ CASE
GW67ST0980	9x9" (23x23cm)	20	80
GW67ST25	12x12" (30x30cm)	20	25
GW67ST60	12x12" (30x30cm)	5	60
GW67ST1242	12x12" (30x30cm)	25	42

No binders or chemical additive

STERILE PRESATURATED WIPERS

KNITTED WIPERS - LOT TO LOT TRACEABILITY

ISO CLASS 3-5

CLEANROOM CLASS 1-100 | EU GRADE A/B/C/D



Sterile SatPax® MicroSeal® 1200 WFI

100% continuous filament polyester knit

Sterile SatPax® MicroSeal® 1200 WFI is pre-wetted with a consistent 70% IPA/30% WFI (Water for Injection) to a high saturation level. It is triple packaged for easy entry into sterile environments. It has been gamma irradiated and sterile validated to a 10⁻⁶ Sterility Assurance Level per ANSI/AAMI/ISO guidelines.

SKU	SIZE	SHEETS/ PACK	PACKS/ CASE	SAT	VOC%
SSPMS015WFI	12x12" (30x30cm)	50	5	60%	41%

Ultrasonically sealed edge, resealable packaging

Sterile SatPax® MSVP

100% continuous filament polyester knit

Sterile SatPax® MSVP is presaturated with a consistent 70% IPA/30% DI water. It has been gamma irradiated and sterile validated to a 10⁻⁶ Sterility Assurance Level per ANSI/AMMI/ISO guidelines.

SKU	SIZE	SHEETS/ PACK	PACKS/ CASE	SAT	VOC%
SSPVP00124	9x9" (23x23cm)	30	24	7%	39.5%
SSPVP00124	9x9" (23x23cm)	30	24	60%	43.2%

Ultrasonically sealed edge, resealable packaging

ISO CLASS 4-5

CLEANROOM CLASS 10-100 | EU GRADE A/B/C/D

Sterile SatPax® 1200

100% continuous filament polyester knit

Sterile SatPax® 1200 is presaturated with a consistent 70% IPA/30% DI Water to a high saturation level for solution contact time in regulated industries. It has been gamma irradiated and sterile validated to a 10⁻⁶ Sterility Assurance Level per ANSI/AAMI/ISO guidelines.

SKU	SIZE	SHEETS/ PACK	PACKS/ CASE	SAT	VOC%
SSP120000312	9x9" (23x23cm)	30	12	60%	40.9%

Knife cut edge, cleanroom laundered, resealable packaging

ISO CLASS 5-8

CLEANROOM CLASS 100-100,000 | EU GRADE A/B/C/D

Sterile SatPax® 1000

55% cellulose/45% polyester

Sterile SatPax® 1000 is presaturated with a consistent 70% IPA/30% DI Water to a high saturation level of 70% for solution contact time in regulated industries. It has been gamma irradiated and sterile validated to a 10⁻⁶ Sterility Assurance Level per ANSI/AAMI/ISO guidelines.

SKU	SIZE	SHEETS/ PACK	PACKS/ CASE	SAT	VOC%
SSP100000124	9x9" (23x23cm)	30	24	60%	44%

Resealable packaging, c-folded for single withdrawal

Sterile SatPax® 670

55% cellulose/45% polyester

Sterile SatPax® 670 is presaturated with a consistent 70% IPA/30% DI Water to a high saturation level of 60% for solution contact time in regulated industries. It has been gamma irradiated and sterile validated to a 10⁻⁶ Sterility Assurance Level per ANSI/AAMI/ISO guidelines.

Sterile SatPax® 550

100% meltblown polypropylene

Sterile SatPax® 550 is a knife cut edge lightweight wiper presaturated with a consistent 70% IPA/30% DI Water. The wipe has very low levels of fibers, particles and ions. It has been gamma irradiated and sterile validated to a 10⁻⁶ Sterility Assurance Level per ANSI/AAMI/ISO guidelines.

Sterile SatPax® Polx® Nonwoven

100% polyester

Sterile SatPax® Polx® Nonwoven is critically low in fiber and particle generation with minimal non-volatile residues making it an exceptional choice for streak-free cleaning. Certificates of Sterility on each case for this 70% IPA/30% DI Water wipe.

SKU	SIZE	SHEETS/ PACK	PACKS/ CASE	SAT	VOC%
SSP67000124	9x9" (23x23cm)	30	24	60%	44%

Resealable packaging, c-folded for single withdrawal

SKU	SIZE	SHEETS/ PACK	PACKS/ CASE	SAT	VOC%
SSP55000424	9x11" (23x28LC)	50	24	62%	48.3%
SSP55000524	7x11" (18x28LC)	50	24	62%	48.3%

Resealable packaging, c-folded for single withdrawal

SKU	SIZE	SHEETS/ PACK	PACKS/ CASE	SAT	VOC%
SSPPNW00124	9x9" (23x23cm)	30	24	60%	45.6%

Resealable packaging, c-folded for single withdrawal

STERILE MOP COVERS & MOP HEADS

Validated Sterile EasyClean® 360 Isolator Cleaning Tool Cover



100% continuous filament polyester knit
Laundered and packaged in an ISO Class 4 (Class 10) cleanroom, this validated sterile cover's stretch fabric and elastic edge enables easy installation and a secure fit on the isolator cleaning tool head.

SKU	COVERS/ PACK	PACKS/ CASE
EC360ECST20	10 ELASTIC COVERS + 1 PADDED COVER	20

Excellent for PEC cleaning (Primary Engineering Controls)

Choice Validated Sterile Padded EasyClean® 360 Isolator Cleaning Tool Cover

100% continuous filament polyester knit

Laundered and packaged in an ISO Class 4 (Class 10) cleanroom, this validated sterile cover's foam-free cushioned design insures even surface coverage with reduced residues.

SKU	PADS/ PACK	PACKS/ CASE
EC360CHPST40	5	40
SSPEC360P40*	5	40

Sterile cover presaturated with 70% IPA/30% DI H₂O available



GAMMA IRRADIATED - LOT TO LOT TRACEABILITY

BCR® Mop 4 Gamma Irradiated



100% knitted polyester
Laundered and cleaned in an ISO Class 4 (Class 10) cleanroom, this gamma irradiated looped string mop head has low particulates and fibers. It has excellent chemical and abrasion resistance.

SKU	MOPS/ PACK	MOPS/ CASE
BCM.4IR.12	1	12

Works well with most mops clamps

Ergonomic Flat Mop Cover Irradiated

Microfiber polyester/nylon fibers

Blue twisted loop microdenier mop cover. Three layer absorbency, individually wrapped.

SKU	SIZE	PADS/ PACK	PACKS/ CASE
FMC8MD10IR	6x18" (45x15cm)	6	10

Polyester knit/polyurethane foam

Laser cut and cleanroom laundered to minimize fiber and particle release. 10mm thickness provides cushioned surface.

SKU	SIZE	PADS/ PACK	PACKS/ CASE
FMC6LF24IR	4.5x15" (11x38cm)	5	24

CHOICE® WIPER SELECTION GUIDE

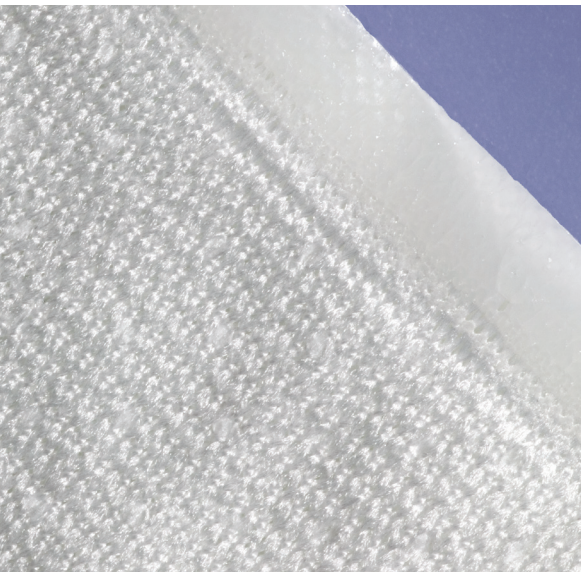

CHOICE® *from* Berkshire®

CHOICE® is a value tiered category of wipers offering all the performance consistency of higher priced wipers. Best of all, **CHOICE®** is from **Berkshire**, the most trusted name in cleanroom supplies, which means quality you can count on. What's more, **CHOICE®** is backed by the Berkshire Guarantee - your money back if our wiper fails to perform according to specifications.

PACKAGING

All Berkshire wipers come in high quality, chemical resistant packaging material that has been tested for cleanroom use. All the wipers are double bagged for easy transfer and wipe down. **CHOICE®** wipers are packaged in stacked and value (bulk) configurations.

VALUE (BULK) PACKAGING

Value (bulk) packaged product is placed into a bag with a cursory inspection. The sheet count is arrived at by weight. There is 0% difference in performance between a value (bulk) packed and stacked product. There is however, a significant cost savings in a value (bulk) packaged wiper.

STACKED PRODUCT

Each wiper is inspected and stacked one on top of the other. The end result is a square pack that allows each wiper to be removed individually from the stack.

KNITTED WIPERS - LOT TO LOT TRACEABILITY - AUTOCLAVABLE

ISO CLASS 3-5 CLEANROOM CLASS 1-100 | EU GRADE B/C/D

PRODUCT/SUBSTRATE	CLEANROOM LAUNDERED	EDGE TYPE	COMPATIBLE WITH IPA, ACETONE, AND OTHER SOLVENTS	VALUE (BULK) OPTION
CHOICE® Edge 100% continuous filament polyester	•	Sealed Border Edge	•	
CHOICE® 700 100% continuous filament polyester	•	Sealed Edge	•	
CHOICE® 900 100% continuous filament polyester	•	Sealed Edge	•	
CHOICE® SuperSorb 100% continuous filament polyester	•	Sealed Edge	•	•
CHOICE® ValuSeal® 100A 100% continuous filament polyester		Sealed Edge	•	

CHOICE® Edge

100% continuous filament polyester

CHOICE® Edge's 4-side border sealed edges increase durability and minimize fiber and particle release during use. The smooth no run interlock knit construction and consistent border edges provide a scratch free wiping surface.

SKU	SIZE	SHEETS/PACK	PACKS/CASE
CHKE09.14	9x9" (23x23cm)	100	14

Sealed Border Edge, Cleanroom Laundered

CHOICE® 700

100% continuous filament polyester

CHOICE® 700's lightweight material design reduces actual cost in use compared to heavier weight products. It has critically low particles, fibers, ions and extractables. It is the most economical knit wiper in the CHOICE® category.

SKU	SIZE	SHEETS/PACK	PACKS/CASE
CH709.14	9x9" (23x23cm)	150	14

Sealed Edge, Cleanroom Laundered

CHOICE® 900

100% continuous filament polyester

CHOICE® 900 has high abrasion resistance with excellent absorbency. Its ultrasonically sealed edges reduces fiber and particle contamination.

SKU	SIZE	SHEETS/PACK	PACKS/CASE
CH909.10	9x9" (23x23cm)	150	10

Sealed Edge, Cleanroom Laundered

CHOICE® SuperSorb

100% continuous filament polyester

CHOICE® SuperSorb is a 2-ply pinsonic constructed cleanroom wiper with a unique diamond pattern. High abrasion resistance with excellent absorbency.



SKU	SIZE	SHEETS/PACK	PACKS/CASE
CHSS09.14	9x9" (23x23cm)	75	14
CHSS09B.14	9x9" (23x23cm)	75 (BULK)	14
CHSS12.12	12x12" (30x30cm)	75	12

Sealed Edge, 2-ply, Cleanroom Laundered

CHOICE® VALUSEAL® 100A

100% continuous filament polyester

CHOICE® ValuSeal® 100A is a tear and abrasion resistant wipe with excellent absorbency. It is ideal for economic high volume cleaning and wipe-downs.

SKU	SIZE	SHEETS/PACK	PACKS/CASE
CHVS100A0910	9x9" (23x23cm)	150	10

Sealed Edge, Cleanroom Laundered

ISO CLASS 5-8 - LOT TO LOT TRACEABILITY - AUTOCLAVABLE CLEANROOM CLASS 100-100,000 | EU GRADE B/C/D

CHOICE® 800

100% continuous filament polyester

CHOICE® 800 has high abrasion resistance and has excellent absorbency. Knife cut edge for reduced scratching potential.

SKU	SIZE	SHEETS/PACK	PACKS/CASE
CH809.10	9x9" (23x23cm)	150	10

Knife Cut Edge, Cleanroom Laundered

CLEANROOM LAUNDERED	EDGE TYPE	COMPATIBLE WITH IPA, ACETONE, AND OTHER SOLVENTS	VALUE (BULK) OPTION
•	Knife Cut Edge	•	

NONWOVEN WIPERS - LOT TO LOT TRACEABILITY - AUTOCLAVABLE

ISO CLASS 5-8

CLEANROOM CLASS 100-100,000 | EU GRADE B/C/D

PRODUCT/SUBSTRATE	CLEANROOM LAUNDERED	EDGE TYPE	COMPATIBLE WITH IPA, ACETONE , AND OTHER SOLVENTS	VALUE (BULK OPTION)
CHOICE® Nonwoven 500 60% cellulose/40% polyester		Knife Cut Edge	•	
CHOICE® Nonwoven 600 55% cellulose/45% polyester		Knife Cut Edge	•	
CHOICE® SatPax 500 Presaturated 60% cellulose/40%		Knife Cut Edge	•	
CHOICE® SatPax 600 Presaturated 55% cellulose/45% polyester		Knife Cut Edge	•	

CHOICE® Nonwoven 500

60% cellulose/40% polyester

CHOICE® is a lighter weight economical all purpose wiper. It is smooth, absorbent and durable.

SKU	SIZE	SHEETS/PACK	PACKS/CASE
CHNW50920	9x9" (23x23cm)	400	20
CHNW51220	12x12" (30x30cm)	200	20

No binders or chemical additives, Stacked

CHOICE® SatPax 500

60% cellulose/40% polyester

CHOICE® SatPax 500 is a lighter weight smooth and durable presaturated wiper with a consistent 70% IPA/30% DI H₂O and 6% IPA/94% DI H₂O* solutions. Reduces VOC emissions.

SKU	SIZE	SHEETS/PACK	PACKS/CASE	SATURATION
SPXCHN500112	9x9" (23x23cm)	75	12	45%
SPXCHN5R00112	9x9" (23x23cm)	75	12	60%
SPXCHN50018*	6x8" (15x20cm)	180	8	45%

No chemical binders in base material, Resealable Packaging

CHOICE® Nonwoven 600

55% cellulose/45% polyester

CHOICE® Nonwoven 600 economical all purpose wiper. It is smooth, absorbent and durable.

SKU	SIZE	SHEETS/PACK	PACKS/CASE
CHNW60440	4x4" (10x10cm)	300	40
CHNW60920	9x9" (23x23cm)	300	20
CHNW61220	12x12" (30x30cm)	150	20

No binders or chemical additives, Stacked

CHOICE® SatPax 600

55% cellulose/45% polyester

CHOICE® SatPax 600 is a smooth and durable presaturated wiper with a consistent 70% IPA/30% DI H₂O solution. Reduces VOC emissions.

SKU	SIZE	SHEETS/PACK	PACKS/CASE	SATURATION
SPXCHN600112	9x9" (23x23cm)	75	12	45%
SPXCHN6R00112	9x9" (23x23cm)	75	12	60%

Knife Cut Edge, Resealable Packaging

DID YOU KNOW?

Isopropyl Alcohol (IPA) is still the

#1 CHOICE IN CLEANROOMS



WATCH VIDEO CHOICE EDGE



WATCH VIDEO CHOICE 900



CHOICE® MOPS & ACCESSORIES

CHOICE® MicroFiber Looped String Mop Head

Microfibers are tiny fibers that have been split to produce ultra-fine fibers estimated to be at least 1/16" the size of a human hair. When knitted together these fibers create a surface area covered with millions of spaces between the fibers to trap moisture, dirt and debris. This technology allows for the dirt and liquids to be "picked up" rather than being pushed around.

Features and Advantages

- White 88% polyester/12% nylon microfiber string mop with blue headband and tailband
- Microfiber yarns attract and trap dirt and debris
- Terry knit structure enhances absorbency to increase efficiency
- Tubular knit construction with sewn head and tail bands provides added durability
- Lot number assures traceability
- Autoclavable

SKU	PACKAGING	MOPS/PACK	MOPS/CASE
CHMFM.24	INDIVIDUALLY WRAPPED	1	24

CHOICE® Mop Handle & Clamp

Economical CHOICE® lightweight mop handle & clamp accommodates most size string and loop mop heads.

Handle: Features and Advantages

- Anodized aluminum handle with blue polypropylene hand grip
- Fixed length at 56 inches (140cm)
- Easily connects to clamp
- Corrosion and chemical resistant
- Not autoclavable

Clamp: Features and Advantages

- Blue polypropylene mop clamp
- Latch-style swing-away bar for quick and easy mophead changes
- Easily connects to handle
- Corrosion and chemical resistant
- Autoclavable

PRODUCT	SKU	PACKAGING	MOPS/HANDLES/ CASE
CHOICE MOP HANDLE & CLAMP SET	CHMH.SET.1	1 HANDLE & 1 CLAMP	1

Choice® EasyClean 360 Padded Covers

100% continuous filament polyester

Laundered and packaged in an ISO Class 4 (Class 10) cleanroom, this cover's foam-free cushioned design insures even surface coverage with reduced residues. Sterile presaturated version available.

SKU	PADS/PACKS	PACKS CASE
EC360CHP40	5	40
EC360CHPST40	5	40
SSPEC360P40*	5	40



DID YOU KNOW ?

The mop head can be relaundersed and re-used. Specific laundry instructions can be found on Product Information Sheet on berkshire.com.



CHOICE® CLEANROOM FACE MASKS

EASY BREATHING COMFORT WITH SUPERIOR PERFORMANCE

People are a significant source of contamination in any critical manufacturing process. Berkshire masks are designed to protect your cleanroom from human contamination. Berkshire masks provide comfort for operators.

Choice® Mask 3-Layer knitted polyester Earloops

- Individually wrapped
- Knitted polyester earloops provide comfort to wearers
- Polypropylene provides excellent filtration

SKU	SIZE	MASKS/ PACK	PACKS/ CASE	INNERFACING MEDIUM	FILTER	OUTERFACING
CHFM18024I	180mm	25	24	NONWOVEN POLYPROPYLENE	POLYPROPYLENE	NONWOVEN POLYPROPYLENE -WHITE



Choice® Mask 3-Layer knitted polyester

- Bulk packaged
- Knitted polyester earloops provide comfort to wearers
- Polypropylene provides excellent filtration

SKU	SIZE	MASKS/ PACK	PACKS/ CASE	INNERFACING MEDIUM	FILTER	OUTERFACING
CHFM1804B	180mm	50	40	NONWOVEN POLYPROPYLENE	POLYPROPYLENE	NONWOVEN POLYPROPYLENE -WHITE

CHOICE® DOCUMENTATION PRODUCTS

CHOICE® Spiral Notebook (College Rule)

Cleanroom bond 72 g/m²

Spiral ring with PET (polyethylene terephthalate) cover can withstand long periods in use. White pages can be written on both sides, 100 pages/50 sheets. Spiral design allows book to lie flat and stay open.

SKU	SIZE	NOTEBOOKS/PACK	PACKS/CASE
CHNBK.0811SR.20	8.5x11" (22x28cm)	1	20
CHNBK.0508SR.40	5.5 x 8.5" (13x20cm)	1	40

DID YOU KNOW ?

College Rule is a style of notebook with paper that has 9/32 inch spacing between horizontal lines, with a vertical margin drawn about 1 1/4 inches from the left-hand edge of the page. It is excellent for those who need more information in a tighter space.

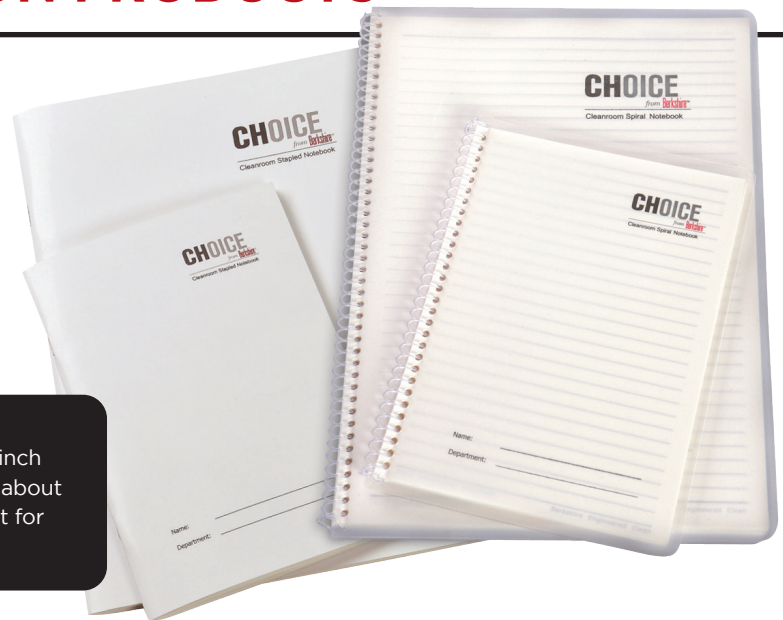

CHOICE® CLEANROOM SOCKS

CHOICE® Cleanroom Socks

99% continuous filament polyester/1% spandex

The socks are laundered and packaged in a ISO Class 5 cleanroom to minimize bioburden levels. They are 1000 times cleaner than regular polyester/cotton socks.

Advantages:

- Meets the requirements of EU GMP Annex 1 section 7.14
- Cleanroom laundry process reduces fiber and particle shedding and minimizes bioburden
- A cost effective, clean and disposable alternative to operators' own socks
- Autoclavable (121°C, 30 minutes)

SKU	SIZE	PAIRS/PACK	PACKS/CASE	STYLE PACKED
CHSOCKR1050	5-11 Regular	10	50	STACKED



ANNEX 1
WHAT DOES IT MEAN
FOR YOUR SOCKS?



GO TO PAGE 54 TO LEARN MORE ABOUT OUR NEW

EZ BLEACH™
DISINFECTANT
TABLETS

PRODUCTS MADE
IN THE USA



PRO-WIPE® INDUSTRIAL WIPERS GUIDE



Pro-Wipe® SE

100% continuous filament polyester

Pro-Wipe® SE is an all-purpose wiper. It is an economical alternative to a standard cleanroom knitted polyester wiper.

Advantages:

- Lot to lot traceability
- Superior durability and strength
- Pre-laundering results in reduced particle contamination
- Chemically compatible with IPA, Acetone and other solvents

SKU	SIZE	STYLE	SHEETS/PACK	PACKS/CASE
PWSEK09.14	9x9" (23x23cm)	Flat Pack	150	14

Sealed Edge, Cleanroom Laundered

Pro-Wipe® OS

100% polypropylene

Pro-Wipe® OS is specifically designed to absorb oil and repel water.

Advantages:

- Lot to lot traceability
- Complies with FDA 21 CFR 176.170 - 177.1520 for food grade applications (3rd party test data available)
- Excellent resistance to acids and bases
- Low linting

SKU	SIZE	STYLE	SHEETS/PACK	PACKS/CASE
PWOS12.12	12x12" (30x30cm)	Flat Pack	100	12



Pro-Wipe® AP

50% rayon/50% polyester

Pro-Wipe® AP is an all purpose wiper. It is tough enough to be a rag replacement and clean enough for a controlled environment.

Advantages:

- Lot to lot traceability
- Smooth and soft with high strength and durability
- High absorbency compared to typical cellulose/polyester nonwoven wipers
- Low linting and abrasion resistant

SKU	SIZE	STYLE	SHEETS/PACK	PACKS/CASE
PWAP09.24	9x9" (23x23cm)	FLAT PACK	150	24
PWAP12.24	12x12" (30x30cm)	FLAT PACK	100	24
PWAP1213QF20	12x13" (30x33cm)	QUARTER FOLDED	50	20
PWAP:PR0915.4	9x15" (23x38cm)	PERFORATED ROLL	250	4

Cloth-Like Feel

Pro-Wipe® SuperSorb

80% cellulose/10% lyocell/10% biocomponent

Pro-Wipe SuperSorb is a medium duty all purpose wipe that is clean enough for controlled environments.

Advantages:

- Absorbs water and oil based solutions
- Good wet strength
- Chemically compatible with common cleaning and disinfecting solutions
- Dispenser box available with wipes

SKU	SIZE	STYLE	SHEETS/PACK	PACKS/CASE
PWSS1114QF18	11x14" (27x35cm)	Quarter Folded	50	18

SKU	SIZE	STYLE	SHEETS /DISPENSER	DISPENSERS /CASE
PWSS0914D16	9x14" (23x36cm)	C-FOLD	90	16

Pro-Wipe® SuperSorb Lite

80% cellulose/10% lyocell/10% biocomponent

Pro-Wipe SuperSorb Lite is a light duty all purpose industrial wipe that is clean enough for controlled environments.

Advantages:

- Chemically compatible with common cleaning and disinfecting solutions
- Smooth and soft with high strength and durability
- Dispenser box available with wipes

SKU	SIZE	STYLE	SHEETS/PACK	PACKS/CASE
PWSSL1114QF18	11x14" (27x35cm)	Quarter Folded	50	18

SKU	SIZE	STYLE	SHEETS /DISPENSER	DISPENSERS /CASE
PWSSL0914D16	9x14" (23x36cm)	C-FOLD	110	16



BCR® DOCUMENTATION SYSTEMS

Paper and notebooks can be a major source of particles, bacteria and micro-organisms in the cleanroom. BCR® Documentation Systems are made with the highest quality BCR® Bond paper to minimize contamination.



ISO CLASS 3-7
CLEANROOM CLASS 1 - 10,000 | EU GRADE B/C/D

BCR® Bond: Single Sheet Cleanroom Paper

104 g/m² (28lb)

PRODUCT	COLOR	WEIGHT	SKU	SIZE	SHEETS/PACK	PACKS/CASE	DOUBLE PACKED
BCR® Bond 1040	White	Heavy	BB10408110W	8.5x11" (22x28cm)	250	10	●
BCR® Bond 1040	Blue	Heavy	BB10408110B	8.5x11" (22x28cm)	250	10	●
BCR® Bond 1040	White	Heavy	BB10411175W	11x17" (28x43cm)	250	5	●
BCR® Bond 1040	Blue	Heavy	BB10411175B	11x17" (28x43cm)	250	5	●

85 g/m² (24lb)

PRODUCT	COLOR	WEIGHT	SKU	SIZE	SHEETS/PACK	PACKS/CASE	DOUBLE PACKED
BCR® Bond 850	White	Medium	BB85081110W	8.5x11" (22x28cm)	250	10	●
BCR® Bond 850	Blue	Medium	BB85081110B	8.5x11" (22x28cm)	250	10	●
BCR® Bond 850	Yellow	Medium	BB85081110C	8.5x11" (22x28cm)	250	10	●
BCR® Bond 850	Pink	Medium	BB85081110P	8.5x11" (22x28cm)	250	10	●
BCR® Bond 850	Green	Medium	BB85081110G	8.5x11" (22x28cm)	250	10	●

68 g/m² (18lb)

PRODUCT	COLOR	WEIGHT	SKU	SIZE	SHEETS/PACK	PACKS/CASE	DOUBLE PACKED
BCR® Bond 680	White	Light	BB6808118W	8.5x11" (22x28cm)	500	8	●
BCR® Bond 680	Blue	Light	BB6808118B	8.5x11" (22x28cm)	500	8	●

ADVANTAGES

- Purest cellulose minimizes contamination
- Full lot tracing on every **case** ensures consistent quality and control
- Specialized coating reduces particles and fibers generation
- Retains ink from copiers and printers to reduce smudging
- Heat resistant under extreme printer temperatures

APPLICATIONS

- Cleanroom manuals, work instructions, standard operating procedures (SOPs)

NATURAL RUBBER-LATEX FREE

BCR® DOCUMENTATION SYSTEMS

ISO CLASS 3-7

CLEANROOM CLASS 1 - 10,000 | EU GRADE B/C/D

EcoBond®: Single Sheet Cleanroom Paper

85 g/m² (24lb)

PRODUCT	COLOR	WEIGHT	SKU	SIZE	SHEETS/PACK	PACKS/CASE	DOUBLE PACKED
EcoBond®	White	Medium	EC0850811WH	8.5x11" (22x28cm)	250	10	●

ADVANTAGES

- Purest cellulose minimizes contamination
- Full lot tracing on every **case** ensures consistent quality and control
- Talc free
- Good toner adhesion
- High strength and heat resistance

APPLICATIONS

- Cleanroom manuals, work instructions, standard operating procedures (SOPs)

ISO CLASS 3-7

CLEANROOM CLASS 1 - 10,000 | EU GRADE B/C/D

BCR® Cleanroom Spiral Notebooks

104 g/m² (28lb)

PRODUCT	COLOR	WEIGHT AND STYLE	SKU	SIZE	NTBK/ PACK	PACKS/ CASE	DOUBLE PACKED
BCR® 1040 Spiral Notebook	White	Heavy College Rule	BSNB.0508CR.20	5.5x8.5" (14x22cm)	1	20	●
BCR® 1040 Spiral Notebook	White	Heavy 1/4 Inch Grid	BSNB05081420	5.5x8.5" (14x22cm)	1	20	●
BCR® 1040 Spiral Notebook	White	Heavy College Rule	BSNB.0811CR.10	8.5x11" (22x28cm)	1	10	●
BCR® 1040 Spiral Notebook	White	Heavy 1/4 Inch Grid	BSNB08111410	8.5x11" (22x28cm)	1	10	●

BCR® CleanNotes®

104 g/m² (28lb)

PRODUCT	COLOR	WEIGHT AND STYLE	SKU	SIZE	SHTS/ PAD	PADS/ CASE
BCR® Cleanotes®	White	Heavy adhesive pad	BCN030324	3x3" (76x76cm)	100	24
BCR® Cleanotes®	White	Heavy adhesive pad	BCN030324B (BULK)	3x3" (76x76cm)	100	24



DID YOU KNOW ?

1/4 Inch Grid (Narrow ruled) paper has 1/4 inch spacing between ruling lines, and is used by those with smaller handwriting or to fit more lines per page.

DID YOU KNOW ?

College rule paper has 9/32 inch spacing between horizontal lines, with a vertical margin drawn about 1 1/4 inches from the left-hand margin. It is excellent for those who need more information in a tighter space.

HAND HEALTH AND OPERATOR COMFORT

BCR® glove liners are manufactured without the use of latex. Glove liners enhance operator comfort by reducing perspiration and contact/heat dermatitis associated with wearing latex, nitrile, neoprene and other gloves. They are ambidextrous for easy stock control and can be relaundered for multiple use.

Each glove liner is constructed using a special seamless technique.

BCR® Polyester Glove Liners

Lightweight

PRODUCT	SKU	SIZE	CUFF COLOR	PAIRS/PACK	PACKS/CASE
BCR® Half-Finger	BGL2.20R	Regular	White	10	20
BCR® Half-Finger	BGL2.200BR	Regular	White	200 (bulk)	1
BCR® Half-Finger	BGL2.20L	Large	Blue	10	20
BCR® Full-Finger	BGL3.20L	Large	Blue	10	20
BCR® Full-Finger	BGL3.20R	Regular	White	10	20

BCR® Single Knit Nylon Glove Liners

Medium Weight

PRODUCT	SKU	SIZE	CUFF COLOR	PAIRS/PACK	PACKS/CASE
BCR® Half-Finger	BGL6.200SB	Small	Green	200 (bulk)	1
BCR® Half-Finger	BGL6.200LB	Large	Black	200 (bulk)	1
BCR® Full-Finger	BGL7.200SB	Small	Red	200 (bulk)	1
BCR® Full-Finger	BGL7.200MB	Medium	Orange	200 (bulk)	1
BCR® Full-Finger	BGL7.200LB	Large	Blue	200 (bulk)	1
BCR® Full-Finger	BGL7.200XLB	X-Large	Red	200 (bulk)	1

BCR® Ultra Glove Liners

Medium Weight

Fortify•AM® and Fortify Sta•Cool® Polyester Glove Liners

PRODUCT	SKU	SIZE	CUFF COLOR	PAIRS/PACK	PACKS/CASE
BCR® Half-Finger	BGL2U20R	Regular	Grey	10	20
BCR® Half-Finger	BGL2U20L	Large	Purple	10	20
BCR® Full-Finger	BGL3U20R	Regular	Grey	10	20
BCR® Full-Finger	BGL3U20L	Large	Purple	10	20

Fortify•AM® technology protects the fabric from microbial growth. The protection does not diminish with laundering and reuse.

Fortify Sta•Cool® technology provides the glove liners with superior cool feeling for extreme moisture management. They reduce the odor caused by hand perspiration.



Half-finger versions are ideal for operators who need to retain maximum dexterity and fingertip sensitivity.

Each glove size has a colored cuff for easy stock control.



BCR® FACE MASKS

ISO CLASS 4-8

CLEANROOM CLASS 10 - 100,000 | EU GRADE B/C/D

EASY BREATHING COMFORT WITH SUPERIOR PERFORMANCE

People are a significant source of contamination in any critical manufacturing process. Berkshire masks are designed to protect your cleanroom from human contamination. Berkshire masks provide comfort for operators.

BCR Mask 3-Layer Knitted Nylon Spandex Earloops

- Individually wrapped
- Ultrasonic bonding reduces contamination and outgassing

SKU	SIZE	MASKS/ PACK	PACKS/ CASE	INNERFACING MEDIUM	FILTER	OUTERFACING
BM180ELK25I	180mm	25	42	Polypropylene	Polypropylene	Polypropylene - Blue

BCR® Mask 3-Layer Polyurethane Headbands - Extra Wide

- Bulk packaged - not individually wrapped in the pack
- Headband option provides more secure facial seal

SKU	SIZE	MASKS/ PACK	PACKS/ CASE	INNERFACING MEDIUM	FILTER	OUTERFACING
BM210HBPU50B	210mm	50 (bulk)	36	Polypropylene	Polypropylene	Polypropylene - Blue

BCR Mask 3-Layer Knitted Nylon Spandex Earloops

- Bulk packaged-not individually wrapped in the pack
- Earloops are soft and comfortable for long wear

SKU	SIZE	MASKS/ PACK	PACKS/ CASE	INNERFACING MEDIUM	FILTER	OUTERFACING
BM180ELK50B	180mm	50 (bulk)	30	Polypropylene	Polypropylene	Polypropylene - Blue

BCR Face Mask 3-Layer Knitted Nylon Spandex Earloops-Extra Wide

- Bulk packaged - not individually wrapped
- Earloops are soft and comfortable for long wear

SKU	SIZE	MASKS/ PACK	PACKS/ CASE	INNERFACING MEDIUM	FILTER	OUTERFACING
BM210ELK50B	210mm	50 (bulk)	30	Polypropylene	Polypropylene	Polypropylene - Blue

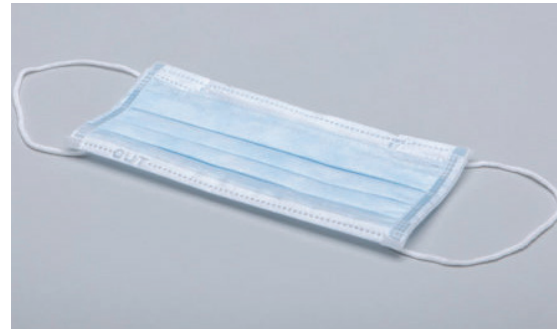
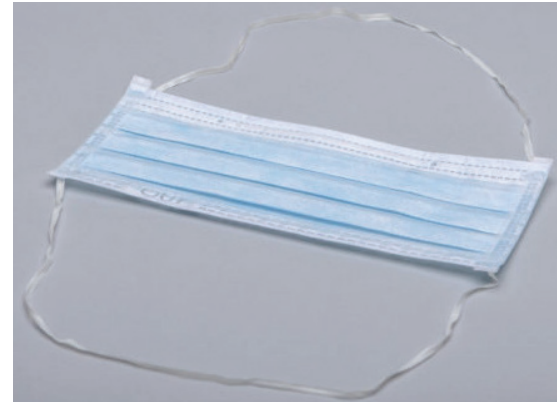

DID YOU KNOW ?

Test results for Particle Filtration Efficiency, Bacterial Filtration Efficiency, Differential Pressure and Helmke Drum can be found on Product Information Sheets located at berkshire.com/product-data

CAN CLEANROOM FACE MASKS CAUSE SKIN IRRITATION?



LAB-TIPS® SWABS GUIDE

Berkshire's LabTips® swabs are exceptionally pure for precision cleaning, surface sampling, applying lubricants and other liquids, and other validation procedures.

SWAB SELECTION GUIDE

PRODUCT	HEAD MATERIAL	SWAB FORM	HEAD TYPE	HANDLE LENGTH	LAUNDERED	TOC	ESD
LTP70F	KNITTED POLYESTER	SOCK	FLEXIBLE	SHORT	●		
LTP70R	KNITTED POLYESTER	SOCK	RIGID	SHORT	●		
LTP125	KNITTED POLYESTER	SOCK	RIGID	MEDIUM	●		
LTP125S	KNITTED POLYESTER	SOCK	SEMI-FLEXIBLE	MEDIUM	●		
LTP1465	KNITTED POLYESTER	SOCK	FLEXIBLE	LONG	●		
LTP1465ESD	KNITTED POLYESTER	SOCK	FLEXIBLE	LONG	●		●
LTO70F	OPEN CELL FOAM	SOCK	RIGID	SHORT	●		
LTO70R	OPEN CELL FOAM	SOCK	RIGID	SHORT	●		
LTO70RES	OPEN CELL FOAM	SOCK	RIGID	SHORT	●		●
LTO70P	OPEN CELL FOAM	SOCK	RIGID	SHORT	●		
LTO70PES	OPEN CELL FOAM	SOCK	RIGID	SHORT	●		●
LTA03163	OPEN CELL FOAM	SOCK	RIGID	SHORT	●		
LT000125	OPEN CELL FOAM	SOCK	RIGID	MEDIUM	●		
LT01465	OPEN CELL FOAM	SOCK	FLEXIBLE	LONG	●		
LTC125	CLOSED CELL FOAM	SOCK	RIGID	MEDIUM			
LTN70F	NONWOVEN POLYESTER	SOCK	FLEXIBLE	SHORT			
LTN1465	NONWOVEN POLYESTER	SOCK	FLEXIBLE	LONG			

CONSTRUCTION

Sock tips are made by sandwiching the swab handle between multiple layers of thermoplastic head material. The head material is completely sealed and bonded to the handle with heat and pressure. No contaminating adhesives are used in the manufacturing of Berkshire's sock tip swabs.

PACKAGING

Lab-Tips® are double bagged in cleanroom bags manufactured from high purity polyethylene resin that ensures ultra-low organic and inorganic residues. Bags are free from silicone, amides, and DP and comply with RoHS directives. An easy tear notch and solvent resistant inner pack labels ensure ease of use.

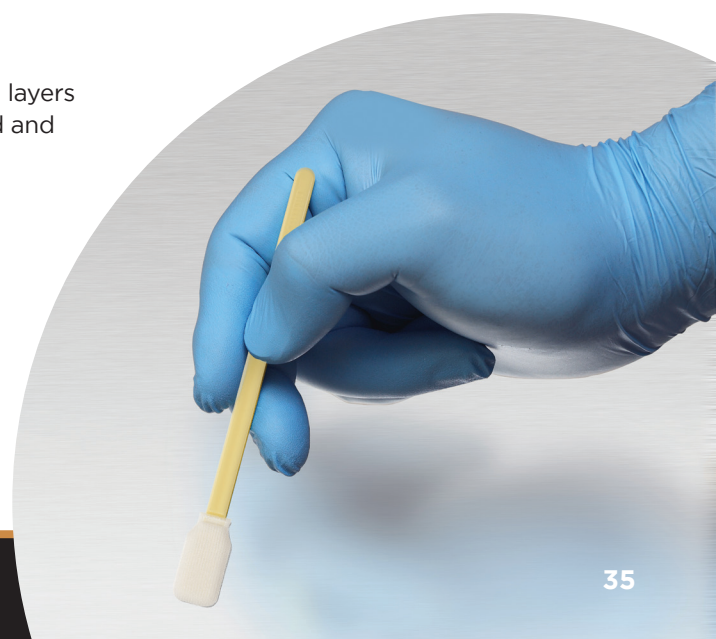

LAB-TIPS® KNITTED POLYESTER SWABS

CLEANROOM LAUNDERED DOUBLE LAYER 100% POLYESTER KNIT SWAB HEADS

Berkshire's knitted polyester swabs are made from cleanroom laundered, continuous filament polyester for exceptional purity. They offer low ionic contamination levels along with excellent durability and absorbent capacity. Knitted polyester swabs have excellent chemical resistance and are compatible with organic solvents. The handles are made of 100% polypropylene.

SKU	HEAD WIDTH	HEAD THICKNESS	HEAD LENGTH	HANDLE WIDTH	HANDLE THICKNESS	HANDLE LENGTH	TOTAL SWAB LENGTH	PACKAGING
LTP70F.20	4.0mm (0.157")	2.5mm (0.098")	11.0mm (0.433")	2.2mm (0.086")	2.2mm (0.086")	59.0mm (2.32")	70.0mm (2.75")	100 SWABS/PACK 20 PACKS/CASE

Polyester swab with flexible paddle head for cleaning grooved, slotted and recessed areas.

SKU	HEAD WIDTH	HEAD THICKNESS	HEAD LENGTH	HANDLE WIDTH	HANDLE THICKNESS	HANDLE LENGTH	TOTAL SWAB LENGTH	PACKAGING
LTP70R.20	4.0mm (0.157")	4.0mm (0.157")	12.5mm (0.492")	2.8mm (0.11")	2.8mm (0.11")	58.0mm (2.28")	70.0mm (2.75")	100 SWABS/PACK 20 PACKS/CASE

Polyester swab with a short handle and rigid core provide firm support and precise control

SKU	HEAD WIDTH	HEAD THICKNESS	HEAD LENGTH	HANDLE WIDTH	HANDLE THICKNESS	HANDLE LENGTH	TOTAL SWAB LENGTH	PACKAGING
LTP125.5	12.7mm (0.50")	5.0mm (0.196")	25.0mm (0.984")	5.5mm (0.216")	2.8mm (0.11")	100.0mm (3.94")	125.0mm (4.92")	100 SWABS/PACK 5 PACKS/CASE

Polyester swab with a durable flat head provide maximum surface area for cleaning or sampling broad flat surfaces

SKU	HEAD WIDTH	HEAD THICKNESS	HEAD LENGTH	HANDLE WIDTH	HANDLE THICKNESS	HANDLE LENGTH	TOTAL SWAB LENGTH	PACKAGING
LTP125S.25	12.7mm (0.50")	5.0mm (0.196")	25.0mm (0.984")	5.5mm (0.216")	2.8mm (0.11")	100.0mm (3.94")	125.0mm (4.92")	20 SWABS/PACK 25 PACKS/CASE

Polyester sampling swab with a unique semi-flexible internal paddle and grooves on the handle for easy snapping

LAB-TIPS® KNITTED POLYESTER SWABS

SKU	HEAD WIDTH	HEAD THICKNESS	HEAD LENGTH	HANDLE WIDTH	HANDLE THICKNESS	HANDLE LENGTH	TOTAL SWAB LENGTH	PACKAGING
LTP1465.10	7.0mm (0.275")	4.0mm (0.157")	16.8mm (0.661")	3.1mm (0.122")	3.1mm (0.122")	145.0mm (5.71")	162.0mm (6.38")	100 SWABS/PACK 10 PACKS/CASE
LTP1465ESD10	7.0mm (0.275")	4.0mm (0.157")	16.8mm (0.661")	3.1mm (0.122")	3.1mm (0.122")	145.0mm (5.71")	162.0mm (6.38")	100 SWABS/PACK 10 PACKS/CASE

Polyester swab with a long handle for cleaning hard to reach areas has high abrasion resistance for rigorous cleaning applications



Swab features an ESD pink handle, engineered with a static dissipative polymer and is packaged in an anti-static bag

LAB-TIPS® OPEN CELL (RETICULATED) FOAM SWABS

CLEANROOM LAUNDERED 100 PPI OPEN CELL POLYURETHANE FOAM SWAB HEADS

Open Cell or reticulated foams are structures in which the cell windows have been removed by thermal or chemical means. This process results in a structure that has **excellent liquid retention** and **particle entrapment capability**. Berkshire's open cell foam swabs have **excellent chemical resistance** and are compatible with organic solvents.

PPI = Pores/Linear Inch.
The number of cells per linear inch in the foam membrane. A measure of foam density.

SKU	HEAD WIDTH	HEAD THICKNESS	HEAD LENGTH	HANDLE WIDTH	HANDLE THICKNESS	HANDLE LENGTH	TOTAL SWAB LENGTH	PACKAGING
LTO70F.20	4.0mm (0.157")	2.0mm (0.078")	11.0mm (0.433")	2.2mm (0.086")	2.2mm (0.086")	59.0mm (2.32")	70.0mm (2.75")	100 SWABS/PACK 20 PACKS/CASE

Foam swab with a short handle and flexible core for general purpose cleaning in confined areas with superior particle entrapment capability

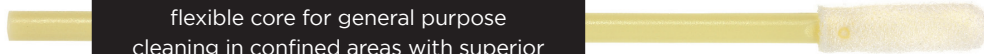

SKU	HEAD WIDTH	HEAD THICKNESS	HEAD LENGTH	HANDLE WIDTH	HANDLE THICKNESS	HANDLE LENGTH	TOTAL SWAB LENGTH	PACKAGING
LTO70R.20	4.0mm (0.157")	4.0mm (0.157")	12.5mm (0.492")	2.8mm (0.11")	2.8mm (0.11")	58.0mm (2.28")	70.0mm (2.75")	100 SWABS/PACK 20 PACKS/CASE
LTO70RES20	4.0mm (0.157")	4.0mm (0.157")	12.5mm (0.492")	2.8mm (0.11")	2.8mm (0.11")	58.0mm (2.28")	70.0mm (2.75")	100 SWABS/PACK 20 PACKS/CASE

Foam swab with a short handle and rigid core for general purpose cleaning in confined areas with superior particle entrapment capability

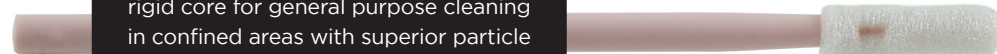

Swab features an ESD pink handle, engineered with a static dissipative polymer and is packaged in an anti-static bag

LAB-TIPS® OPEN CELL (RETICULATED) FOAM SWABS

SKU	HEAD WIDTH	HEAD THICKNESS	HEAD LENGTH	HANDLE WIDTH	HANDLE THICKNESS	HANDLE LENGTH	TOTAL SWAB LENGTH	PACKAGING
LTO70P.20	4.0mm (0.157")	4.0mm (0.157")	20.0mm (0.787")	2.5mm (0.098")	2.5mm (0.098")	50.0mm (1.97")	70.0mm (2.75")	100 SWABS/PACK 20 PACKS/CASE
LTO70PESD20	4.0mm (0.157")	4.0mm (0.157")	20.0mm (0.787")	2.5mm (0.098")	2.5mm (0.098")	50.0mm (1.97")	70.0mm (2.75")	100 SWABS/PACK 20 PACKS/CASE

Foam swab with a precision pointed head and a small tapered handle for cleaning small slotted and grooved areas

Swab features an ESD pink handle, engineered with a static dissipative polymer and is packaged in an anti-static bag

SKU	HEAD WIDTH	HEAD THICKNESS	HEAD LENGTH	HANDLE WIDTH	HANDLE THICKNESS	HANDLE LENGTH	TOTAL SWAB LENGTH	PACKAGING
LTA03163.10	5.0mm (0.19")	3.0mm (0.118")	13.0mm (0.5")	2.4mm (0.093")	2.4mm (0.093")	71.0mm (2.8")	76.0mm (3.0")	100 SWABS/PACK 10 PACKS/CASE

Foam swab with a short handle and rigid core for general purpose cleaning in confined areas with superior particle entrapment capability

SKU	HEAD WIDTH	HEAD THICKNESS	HEAD LENGTH	HANDLE WIDTH	HANDLE THICKNESS	HANDLE LENGTH	TOTAL SWAB LENGTH	PACKAGING
LT000125.10	13.0mm (0.50")	9.0mm (0.35")	25.0mm (1.0")	5.0mm (0.093")	3.0mm (0.12")	125.0mm (4.9")	127.0mm (5.0")	100 SWABS/PACK 10 PACKS/CASE

Foam swab with an absorbent large rectangular flat head provides a maximum surface area for cleaning broad flat surfaces

SKU	HEAD WIDTH	HEAD THICKNESS	HEAD LENGTH	HANDLE WIDTH	HANDLE THICKNESS	HANDLE LENGTH	TOTAL SWAB LENGTH	PACKAGING
LTO1465.10	7.0mm (0.275")	3.0mm (0.118")	16.8mm (0.661")	3.1mm (0.122")	3.1mm (0.122")	145.0mm (5.71")	162.0mm (6.38")	100 SWABS/PACK 10 PACKS/CASE

Foam swab with a long handle for cleaning hard to reach areas with good sorbency and excellent solvent hold

LAB-TIPS® CLOSED CELL (NON-RETICULATED) FOAM SWABS

CLEANROOM LAUNDERED 100 PPI CLOSED CELL POLYURETHANE FOAM SWAB HEADS

Closed Cell or non-reticulated foams are completely sealed with cell windows intact. Closed cell foams generally exhibit higher density, greater durability and reduced absorption versus open cell foams. Berkshire's closed cell foam swabs are manufactured from 100 ppi polyurethane.

SKU	HEAD WIDTH	HEAD THICKNESS	HEAD LENGTH	HANDLE WIDTH	HANDLE THICKNESS	HANDLE LENGTH	TOTAL SWAB LENGTH	PACKAGING
LTC125.5	13.0mm (0.511")	8.0mm (0.315")	25.0mm (0.984")	5.5mm (0.216")	2.8mm (0.11")	100.0mm (3.94")	125.0mm (4.92")	100 SWABS/PACK 5 PACKS/CASE

Foam swab with a durable large rectangular head provide maximum surface area for cleaning broad flat surfaces



DID YOU KNOW ?

What is the difference between a closed cell and open cell swab?



LAB-TIPS® NONWOVEN 100% POLYESTER SWABS

HYDROENTANGLED 100% POLYESTER SWAB HEADS

Swabs made from 100% polyester nonwoven material are absorbent, non-abrasive and have very low ionic contamination and NVR levels. These swabs are also compatible with most solvents.

SKU	HEAD WIDTH	HEAD THICKNESS	HEAD LENGTH	HANDLE WIDTH	HANDLE THICKNESS	HANDLE LENGTH	TOTAL SWAB LENGTH	PACKAGING
LTN70F.20	4.0mm (0.157")	2.0mm (0.078")	11.0mm (0.433")	2.2mm (0.086")	2.2mm (0.086")	59.0mm (2.32")	70.0mm (2.75")	100 SWABS/PACK 20 PACKS/CASE

Nonwoven polyester swab with short handle and small flexible tip for cleaning very small grooved sensitive areas, soft and non-abrasive



SKU	HEAD WIDTH	HEAD THICKNESS	HEAD LENGTH	HANDLE WIDTH	HANDLE THICKNESS	HANDLE LENGTH	TOTAL SWAB LENGTH	PACKAGING
LTN1465.10	7.0mm (0.275")	4.0mm (0.118")	17.0mm (0.67")	3.1mm (0.122")	3.1mm (0.122")	145.0mm (5.71")	162.0mm (6.38")	100 SWABS/PACK 10 PACKS/CASE

Nonwoven polyester swab with a long handle for cleaning hard to reach areas with good sorbency and excellent solvent hold



SWAB/SOLVENT COMPATIBILITY CHART

SOLVENT	HEAD SUBSTRATE	
	FOAM	POLYESTER
ACETIC ACID	U	U
ACETONE	S	U
ACETONITRILE	U	U
AMMONIA, ANHYDROUS	U	U
ANILINE	S	U
BENZENE	S	U
CARBON TETRACHLORIDE	S	U
CHLOROFORM	S	U
CHLOROPHENOL	D	D
CHROMIC ACID	D	D
CYCLOHEXANE	S	U
DIMETHYLFORMAMIDE	D	S
DIMETHYLSULFOXIDE	D	S
ETHYL ACETATE	S	U
ETHYL ALCOHOL	U	U
ETHYL CHLORIDE	S	U
FORMIC ACID	D	U
HEXANE	U	U

SOLVENT	HEAD SUBSTRATE	
	FOAM	POLYESTER
HYDROCHLORIC ACID 48%	D	D
HYDROGEN PEROXIDE	D	U
ISOPROPYL ALCOHOL	U	U
METHANOL	S	U
METHYL ETHYL KETONE	S	U
METHYLENE CHLORIDE	S	U
NITRIC ACID 100%	D	D
NITROBENZENE	S	U
PERCHLOROETHYLENE	U	U
PHOSPHORIC ACID 85%	D	U
SODIUM HYDROXIDE 36%	S	U
SULFURIC ACID 98%	D	D
TOLUENE	S	U
TRICHLOROETHYLENE	S	U
VINYL ACETATE	S	U
WATER	U	U
XYLENE	S	U

NOTE:

U = UNAFFECTED, S = SWELLS, D = DEGRADES

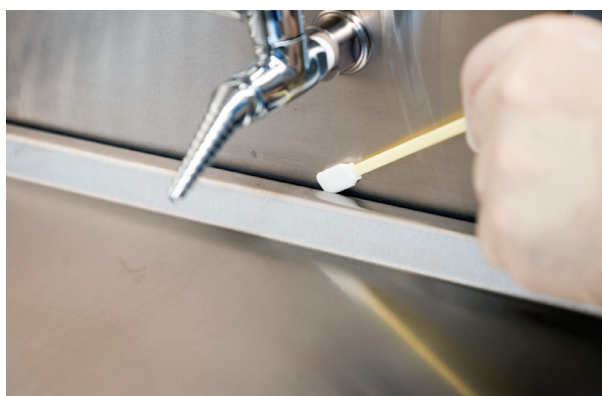

**WHAT IS
ELECTROSTATIC
DISCHARGE (ESD)?**



BCR® MOP SELECTION GUIDE

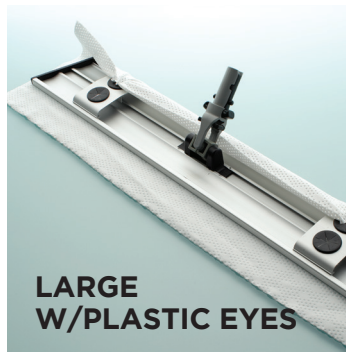
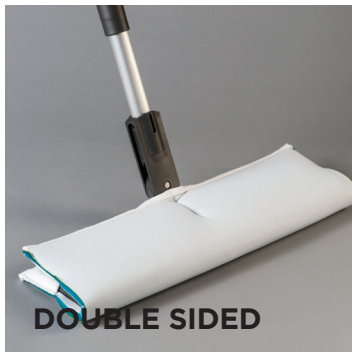

	STRING	CHOICE®	DOUBLE SIDED	ERGONOMIC	LARGE W/ SPRINGS	LARGE W/ PLASTIC EYES	SMALL W/ PLASTIC EYES	EASYSOFT® 360
AUTOCLAVABLE	•	•	•	•	•	•	•	•
FLOORS	•	•	•	•	•	•	•	
WALLS			•	•	•	•	•	
CEILINGS			•	•	•	•	•	
RABS								•
ISOLATORS								•
CACI/CLASS II BSC								•
LARGE AREAS	•	•	•	•	•	•		
SMALL AREAS			•	•	•	•	•	•
UNDER EQUIPMENT			•	•	•	•	•	
WET CLEANING	•	•	•	•	•	•	•	•
DRY CLEANING			•	•	•	•	•	•
GLOVE BOXES								•

CHOICE® MOPS & ACCESSORIES

CHOICE® MicroFiber Looped String Mop Head

Microfibers are tiny fibers that have been split to produce ultra-fine fibers estimated to be at least 1/16" the size of a human hair. When knitted together these fibers create a surface area covered with millions of spaces between the fibers to trap moisture, dirt and debris. This technology allows for the dirt and liquids to be "picked up" rather than being pushed around.

Features and Advantages

- White 88% polyester/12% nylon microfiber string mop with blue headband and tailband
- Microfiber yarns attract and trap dirt and debris
- Terry knit structure enhances absorbency to increase efficiency
- Tubular knit construction with sewn head and tail bands provides added durability
- Lot number assures traceability
- Autoclavable

SKU	PACKAGING	MOPS/PACK	MOPS/CASE
CHMFM.24	INDIVIDUALLY WRAPPED	1	24

CHOICE® Mop Handle & Clamp

Economical CHOICE® lightweight mop handle & clamp accommodates most size string and loop mop heads.

Handle: Features and Advantages

- Anodized aluminum handle with blue polypropylene hand grip
- Fixed length at 56 inches (140cm)
- Easily connects to clamp
- Corrosion and chemical resistant
- Not autoclavable

Clamp: Features and Advantages

- Blue polypropylene mop clamp
- Latch-style swing-away bar for quick and easy mophead changes
- Easily connects to handle
- Corrosion and chemical resistant
- Autoclavable

PRODUCT	SKU	PACKAGING	MOPS/HANDLES/ CASE
CHOICE MOP HANDLE & CLAMP SET	CHMH.SET.1	1 HANDLE & 1 CLAMP	1

DID YOU KNOW ?

The mop head can be relaundered and re-used. Specific laundry instructions can be found on Product Information Sheet on berkshire.com.



BCR® CLEANROOM LOOPED STRING MOP SYSTEM

Cleanroom Looped String Mop Heads

Looped-end-fan-tail construction to minimize particle generation

BCR® Mop 1

Nonwoven polyester — Disposable

This is an absorbent, economical, unlaundered soft mop designed for both the easy removal of contamination from floors and for the distribution of disinfectants.

PRODUCT	SKU	MOP/PACK	MOPS/CASE
BCR® MOP 1	BCM.1.12	1	12



BCR® Mop 4

100% knitted polyester — Relaunderable
Laundered and packaged in an ISO Class 4 cleanroom, this mop has low particulates and fibers. It has excellent chemical and abrasion resistance, with a lot number on each pack ensuring traceability. Available gamma irradiated.

PRODUCT	SKU	MOP/PACK	MOPS/CASE
BCR® MOP 4	BCM.4.12	1	12
BCR® MOP 4	BCM.4IR.12	1	12

CLEANROOM STRING AND LOOP MOP HANDLE & CLAMP

Handle: Features and Advantages

- Anodized aluminum handle
- Fixed length of 56" (140cm)
- Lightweight
- Easily connects to clamp
- Corrosion and chemical resistant
- Not Autoclavable

Clamp: Features and Advantages

- Blue polypropylene mop clamp
- Latch-style swing-away bar for quick and easy mophead changes
- Easily connects to handle
- Autoclavable
- Corrosion and chemical resistant

PRODUCT	SKU	PACKAGING	MOPS/HANDLES/ CASE
CHOICE MOP HANDLE & CLAMP SET	CHMH.SET.1	1 HANDLE & 1 CLAMP	1

DID YOU KNOW ?

Certificates of Irradiation are available 24/7 on berkshire.com for BCM.4IR.12

Cleanroom Looped String Mop Wringer, Cart and Buckets

Composition and Technology

- The Cleanroom Cart is made of high quality stainless steel and is fully autoclavable
- Locking casters provide stability
- Wringer is made of durable plastic
- Ergonomically designed handle serves as a rest for the mop handle and makes the cart easy to maneuver in tight production areas
- Two 20 liter polypropylene buckets are color coded grey and red to differentiate between clean and dirty solutions

**Internal bucket graduations help insure correct mixing of cleaning and disinfecting solutions*

PRODUCT	SKU	QTY PER CASE
STAINLESS STEEL MOP CART WITH BUCKETS	BCRMOPCART1	1
MOP WRINGER	BCRSTRWRINGER1	1
REPLACEMENT CASTER SET	BCRCASTERSET1	4



HANDLE AND CLAMP ASSEMBLY INSTRUCTIONS



EASYCLEAN® 360 ISOLATOR CLEANING SYSTEM



ISOLATOR CLEANING TOOL (ICT)

Efficient cleaning of compounding isolators, biological safety cabinets, laminar flow hoods and other mini-environments is critical to the quality and purity of compounded products. The EasyClean® 360° System includes a lightweight, maneuverable cleaning tool along with easy-to-use laundered polyester knit covers.

- Durable, mirror finish, stainless steel mop head swivels 360° for easy maneuverability
- Head can be locked for 180° swivel when desired
- 4x7" (10x18cm) triangular head shape allows improved access to tight corners.
- Lightweight anodized aluminum handles provided in 2 lengths - 14" (35cm) and 24" (61cm)
- Mop head and handles can be sterilized by autoclave or gamma irradiation



PRODUCT

EASYCLEAN® 360 ISOLATOR CLEANING TOOL

TELESCOPING ALUMINUM HANDLE

SKU

EC360.ICT.1

HANDLE SIZES

14" & 24" (35cm & 61cm)

QTY PER CASE

1

BCR.T2HANDLE.1

37" - 71" (95 - 180cm)

1 (SOLD SEPARATELY)



EASYCLEAN® ICT ELASTIC & PADDED COVERS

- Made from Super Polx® 1200 continuous filament polyester
- Laundered and packaged in an ISO Class 4 cleanroom
- Stretch fabric and elastic edge allow easy installation and secure fit
- Recommended for use with the EasyClean® 360 knitted polyester padded cover
- Padded cover cushioned design ensures even surface coverage
- Choice® padded covers on page 27

PRODUCT

EASYCLEAN® ELASTIC ICT COVERS

STERILE EASYCLEAN®

EASYCLEAN® 360 PADDED ICT COVERS

SKU

EC360EC6

EC360ECST20

EC360.PAD.6

PACKAGING

25 ELASTIC COVERS & 1 PADDED COVER/PACK

10 ELASTIC COVERS & 1 PADDED COVER/PACK

25 PADDED COVERS

PACKETS/CASE

6

20

6

EASYCLEAN® NONWOVEN ICT COVERS

- Double-ply 55% cellulose/45% polyester
- 100% nonwoven rayon inner layer for added absorbency
- Elastic edge allows secure fit on the mop head during use
- Autoclavable

PRODUCT

EASYCLEAN® ICT COVERS

SKU

EC360.NW.40

PACKAGING

5 COVERS/PACK
4 PACKS/PACKET

PACKETS/CASE

10

Light weight anodized aluminum handles provided in 2 lengths — 14" (35cm) and 24" (61cm)

Head can be locked for 180° swivel when desired

Mop head and handles can be sterilized by autoclave or gamma irradiation

4x7" (10x18cm) triangular head shape allows improved access in tight corners

Durable, mirror finish, stainless steel mop head swivels 360° for easy maneuverability



ERGONOMIC 16" CLEANROOM FLAT MOP SYSTEM

The ergonomic 16" Flat Mop holder is a versatile flat mop suitable for almost all application areas. Your cleanroom staff can attach mops faster and more efficiently than ever. Thanks to the cleanroom flat mops V shape, it slips smoothly into the pouches of the mop reducing bending and decreasing injury.

- Ergonomic working hand-switch opening of the holder and mop discarding while standing upright
- No touching of soiled mops when discarding
- Completely flat action for cleaning under and behind equipment

PRODUCT	SKU	SIZE	QTY PER CASE
V FLAT MOP HOLDER WITH CLIPS	BCRVSMOP10	4x16" (10x40cm)	10 V FLAT MOPS/20 CLIPS
V FLAT MOP HOLDER WITH CLIPS	BCRVSMOP1	4x16" (10x40cm)	1 V FLAT MOPS/2 CLIPS
TELESCOPING HANDLE	BCRHANDLE10	35-65" (89-165cm)	10
TELESCOPING HANDLE	BCRHANDLE1	35-65" (89-165cm)	1
V FLAT MOP CLIPS	BCRVSCIP20	N/A	20 (NOT AUTOCLAVABLE)

CLEANROOM ERGONOMIC FLAT MOP COVERS (Available Gamma Irradiated)

PRODUCT	SKU	SIZE	COVERS/PACK	PACKS/CASE
V MOP NONWOVEN COVER	FMC4NW20	4.5x15" (11x38cm)	10	20
V MOP FOAM COVER	FMC6LF12	4.5x15" (11x38cm)	10	20
V MOP MICRODENIER COVER	FMC8MD10	6.0x18" (45x15cm)	6	10
IR V MOP MICRODENIER COVER	FMC8MD10IR	6.0x18" (45x15cm)	6	10
IR V MOP FOAM COVER	FMC6LF24IR	4.5x15" (11x38cm)	5	24

Wringer, Sieve, Cart And Buckets

PRODUCT	SKU	QT PER CASE	PACKS/CASE
STAINLESS STEEL MOP CART WITH BUCKETS - 2.20 LITER BUCKETS , BLUE, RED	BCRMOPCART1	1	1
STAINLESS STEEL V FLAT MOP WRINGER	BCRVSWRINGER1	1	1
STAINLESS STEEL V FLAT MOP SIEVE	BCRFMSIEVE1	1	1
REPLACEMENT CASTERS SET	BCRCASTERSET1	1 (QTY/PACK)	1 (PACKS/CASE)

Autoclavable Mop Wipers

PRODUCT	SKU	SIZE	COVERS/PACK	PACKS/CASE
DURX® 670	DR670101810	10x18"	100	10
MICROSEAL®-VP	MSVP1018B10	10x18"	50 (BULK)	10
MICROSEAL SUPERSORB® LITE	SSLT1018B10	10x18"	25 (BULK)	10
MICROPOLX® 2750	MPX2750101810	10x18"	50	10

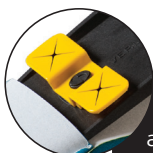

Detachable wiper clips allow the use of disposable mop wipers, but are not autoclavable

Polypropylene grip

Fully autoclavable lightweight durable anodized aluminum telescopic handle extends from 35-65" (89-165cm)

Easy insertion of the holder into the pouches of the mop cover thanks to the V shape



ERGONOMIC FLAT MOP WRINGER, SIEVE, CART AND BUCKETS

Composition and Technology

- The Cleanroom Mop Cart is made of high quality stainless steel and is fully autoclavable.
- Locking casters provide stability during use.
- Wringer is made of high quality stainless steel.
- Ergonomically designed handle serves as a rest for the mop handle and makes the cart easy to maneuver in tight production areas.
- Two 20 liter polypropylene buckets are color coded grey and red to differentiate between clean and dirty solutions.
- Internal bucket graduations help insure correct mixing of cleaning and disinfecting solutions



PRODUCT	SKU	QTY PER CS	PKS/CS
STAINLESS STEEL MOP CART WITH BUCKETS — 2, 20 LITER BUCKETS, GREY, RED	BCRMOPCART1	1	1
STAINLESS STEEL V FLAT MOP WRINGER	BCRVSWRINGER1	1	1
STAINLESS STEEL V FLAT MOP SIEVE	BCRFMSIEVE1	1	1
REPLACEMENT CASTERS SET	BCRCASTERSET1	1 (PACK/CASE)	4



AUTOCLAVABLE CLEANROOM MOP WIPERS

Durx® 670	SKU	SIZE	SHEETS/PACK	PACKS/CASE
Nonwoven, 45% polyester/55% cellulose blend	DR670101810	10x18" (25x46cm)	100	10
MicroSeal®-VP				
Sealed edge, 100% knitted polyester, laundered	MSVP1018B10	10x18" (25x46cm)	50 (BULK)	10
MicroSeal SuperSorb® Lite				
Sealed edge, 2-ply, 100% knitted polyester, laundered	SSLT1018B10	10x18" (25x46cm)	25 (BULK)	10
MicroPolx® 2750				
Polyester/nylon, microfiber knitted	MPX2705101810	10x18" (25x46cm)	50	10

DOUBLE SIDED 16" CLEANROOM FLAT MOPPING SYSTEM

The Double Sided Flat Mop holder's unique design allows operators to clean approximately twice the surface area of a conventional flat mop before changing or re-saturating the mop head, improving cleaning efficiency and reducing cleaning time.



CLEANROOM DOUBLE SIDED FLAT MOP HOLDER

- Attachment and removal of the mop covers without bending
- Extremely maneuverable with a 360° swiveling head and flat profile-ideal for cleaning under and around production equipment
- Durable, autoclavable plastic
- Double the surface coverage of conventional flat mopping systems
- Edge mounted handle design perfect for cleaning baseboards



CLEANROOM FLAT MOP TELESCOPING HANDLE

- Durable anodized aluminum with polypropylene grip
- Fully autoclavable, polypropylene grip, lightweight durable anodized aluminum telescopic handle extends from 35 - 65" (89-165cm)

PRODUCT	SKU	SIZE	QTY PER CASE
DOUBLE SIDED MOP HOLDER	BCRDSMOP10	4x16" (10x40cm)	10
DOUBLE SIDED MOP HOLDER	BCRDSMOP1	4x16" (10x40cm)	1
TELESCOPING HANDLE	BCRHANDLE10	35-65" (89-165cm)	10
TELESCOPING HANDLE	BCRHANDLE1	35-65" (89-165cm)	1

CLEANROOM DOUBLE SIDED FLAT MOP WRINGER CART AND BUCKETS

Composition and Technology

- The Cleanroom Mop Cart is made of high quality stainless steel and is fully autoclavable
- Locking casters provide stability
- Wringer is made of durable plastic
- Ergonomically designed handle serves as a rest for the mop handle and makes the cart easy to maneuver in tight production areas
- Two 20 liter polypropylene buckets are color coded grey and red to differentiate between clean and dirty solutions
- Internal bucket graduations help insure correct mixing of cleaning and disinfecting solutions



PRODUCT	SKU	QTY PER CASE
STAINLESS STEEL MOP CART WITH BUCKETS	BCRMOPCART1	1
DS FLAT MOP WRINGER	BCRDSWRINGER1	1
REPLACEMENT CASTER SET	BCRCASTER1	4

PARTICLES ON SURFACES: CLEANING FLOORS & WALLS



CLEANROOM DOUBLE SIDED FLAT MOP COVERS



Double Sided Mop Foam Cover

- Abrasion resistant polyester knit cleanroom fabric laminated to absorbent polyurethane foam
- Laser cut and cleanroom laundered to minimize fiber and particle release
- High absorbency capacity
- 5mm thickness provides cushioned surface for optimum conformance to uneven floors, walls and ceilings
- Each cover is individually wrapped *Autoclavable

SKU	SIZE	COVERS/PACK	PACKS/CASE
FMC7LF20	10x18" (25x46cm)	4	20

CLEANROOM FLAT MOP WIPERS

All the wipers are disposable and measured to fit the Mop Head Frame. More than one wiper can be attached to the mop head at a time. After mopping the area, the outer wiper can be disposed of and the remaining wipers are ready for the next mopping phase. This guarantees a fresh wiper is used for each new phase.

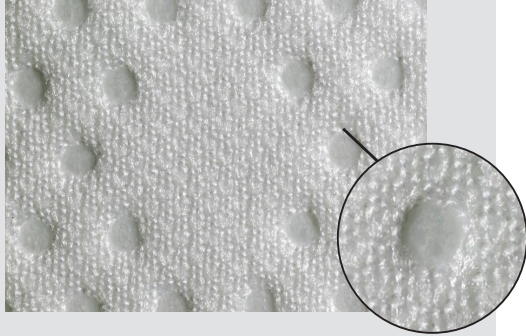

MicroSeal SuperSorb® Flat Mop Wiper

- Two-ply bonded, sealed edge 100% polyester
- Laundered and packaged in an ISO Class 4 (Class 10) cleanroom
- High Abrasion Resistance
- Autoclavable/sterile version available
- Lot number of each pack for traceability

SKU	SIZE	SHEETS/ PACK	PACKS/ CASE
MSSS.0812.12	8x12" (20x30cm)	50	12
MSSS.0824.12	8x24" (20x61cm)	25	12

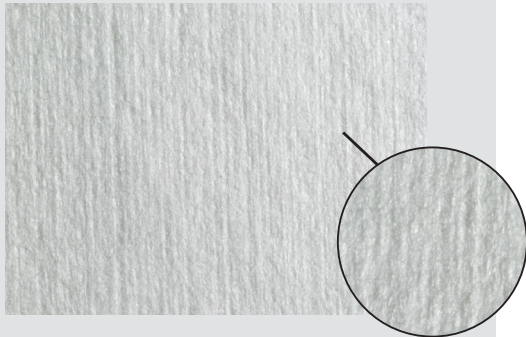

Durx® 670 Flat Mop Wiper

- Hydroentangled 55% cellulose/ 45% polyester
- Smooth, highly sorbent and durable
- Autoclavable/sterile versions available
- No secondary binder
- Critical combination of the strength of synthetic polyester with the absorbency of cellulose
- Lot number of each pack for traceability

SKU	SIZE	SHEETS/ PACK	PACKS/ CASE
DR670.0812.20	8x12" (20x30cm)	100	20
DR670.0824.10	8x24" (20x61cm)	100	10



LARGE
W/SPRINGS

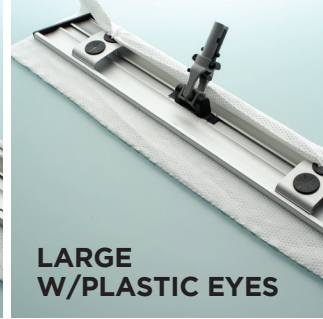

LARGE
W/PLASTIC EYES

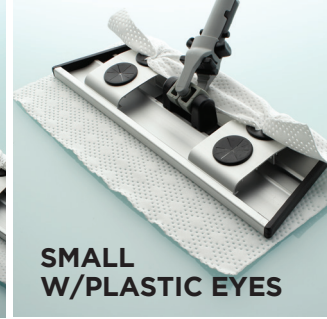

SMALL
W/PLASTIC EYES

BCR® FLAT MOP SYSTEM

Flat Mop Head Frame

Efficient cleaning of floors, wall and other large surfaces is critical to the overall cleanliness of the production environment. BCR® Flat Mop Systems replicate the most effective way to clean a surface - WIPING. Available with a range of wiping substrates to support your level of cleanliness.

Features

- Clean, light and durable
- High quality anodized aluminum
- Autoclavable
- Unique stainless steel spring mechanisms for wiper attachment (Mop 2)
- Plastic eyes for wiper attachment (Mop 3 and 4)

PRODUCT	SKU	SIZE	QUANTITY
BCR® LARGE MOP HEAD FRAME W/SPRINGS	BCR.MOP2.1	3 1/2x23" (9x58cm)	1 PER CASE
BCR® LARGE MOP HEAD FRAME W/SPRINGS	BCR.MOP2.10	3 1/2x23" (9x58cm)	10 PER CASE
BCR® SMALL MOP HEAD FRAME W/PLASTIC EYES	BCR.MOP3.1	3 1/2x11" (9x28cm)	1 PER CASE
BCR® SMALL MOP HEAD FRAME W/PLASTIC EYES	BCR.MOP3.10	3 1/2x11" (9x28cm)	10 PER CASE
BCR® LARGE MOP HEAD FRAME W/PLASTIC EYES	BCR.MOP4.1	3 1/2x23" (9x58cm)	1 PER CASE
BCR® LARGE MOP HEAD FRAME W/PLASTIC EYES	BCR.MOP4.10	3 1/2x23" (9x58cm)	10 PER CASE
BCR® PLASTIC EYE REPLACEMENTS	BCRCLIP10		20 PER CASE

Flat Mop Handle

Features

- Telescopic handle: extends from 37-71" (95-180cm)
- Anodized aluminum; lightweight and strong
- Autoclavable

PRODUCT	SKU	SIZE	QUANTITY
TELESCOPING ALUMINUM HANDLE	BCR.T2HANDLE.1	37-71" (95-180cm)	1 PER CASE
TELESCOPING ALUMINUM HANDLE	BCR.T2HANDLE.10	37-71" (95-180cm)	10 PER CASE



BCR® CLEANROOM SOCKS AND CLEANPATH™ ADHESIVE MATS

BCR® Cleanroom Socks

96% microdenier nylon and 4% lycra

BCR® Cleanroom socks provide the next level of cleanroom foot health and operator comfort. The microdenier technology provides the sock with superior cool feeling and comfort.

Advantages

- One size fits all
- Extremely soft and comfortable – autoclavable (121°C, 30 minutes)
- Advanced technology for extreme moisture management
- Reduced odor caused by foot perspiration

Technical Data

DESCRIPTION	AVERAGE DATA	TEST METHOD
Common Everyday Sock	44607	0.5 µm Helmke Drum: Particles ≥ 0.5 µm/ft ³
Bershire BCR® Sock	22	0.5 µm Helmke Drum: Particles ≥ 0.5 µm/ft ³

PRODUCT	NUMBER	PRS/PK	PKS/CS	STYLE PACKED
BCR®CLEANROOM SOCK	BCRSOCKR24	6	24	STACKED



ISO CLASS 3-8

CLEANROOM CLASS 1 - 100,000 | EU GRADE B/C/D

CleanPath™ Adhesive Mats

LDPE (Low Density Polyethylene)

CleanPath™ Adhesive Mats decrease the transfer of foot-borne and wheel-borne contaminants including viable and non-viable particles.

Advantages

- Adhesive coated surface film peels off easily for disposal
- Layers are numbered for easy tracking of remaining sheets
- Thickness per sheet: 40 Micron
- Blue color aids in the visual observation of tracked contamination
- Economical



PRODUCT	NUMBER	SIZE	LAYERS/MAT	MATS/CS	COLOR
CLEANPATH™ ADHESIVE MAT	CPM18364	18x36" (46x91cm)	30	4	BLUE
CLEANPATH™ ADHESIVE MAT	CPM26454	26x45" (66x114cm)	30	4	BLUE
CLEANPATH™ ADHESIVE MAT	CPM36454	36x45" (91x114cm)	30	4	BLUE
CLEANPATH™ ADHESIVE MAT	CPM36604	36x60" (91x152cm)	30	4	BLUE



Numbered for easy tracking of remaining sheets



ADVANCED CLEANING SYSTEM

Three easy steps to a superior clean



Berkshire is pleased to announce the launch of DuoClean™, an Advanced Cleaning System with a dual action line of wipes and chemistries* featuring our patent pending burstable dry-to-wet pouch. If you are currently buying bulk chemistries, diluting and filtering, you know the reality of added storage, error, labor, & waste costs along with contamination issues transferring to a squirt bottle. If you are using premixed spray bottles, you also have to be concerned about operator error with over spraying the surface and the ramifications. Unlike other disinfectant wipes that

are delivered presaturated, with just 3 easy steps the DuoClean™ wipes and chemistry are activated at the point of use. There is no efficacy or waste issue, since you use the 15 wipe pack the same shift/session. Repacking contaminated or unused wipes for easy discarding is a snap with the peel and reseal pack.

*The CDC and OSHA has recommended sodium hypochlorite and hydrogen peroxide for surface disinfection.

HOW DOES IT WORK?



1 Roll the pack from one end and apply pressure until inner seal bursts or "pops".

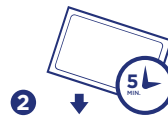

2 Work pack from side to side and let sit face down for 5 minutes



3 Turn pack over and remove wipes, reseal when not in use to preserve

ORDER INFORMATION

HYDROGEN PEROXIDE DUOCLEAN™ 3% HYDROGEN PEROXIDE | DUOCLEAN 6% HYDROGEN PEROXIDE

ITEM #	DESCRIPTION	WIPER TYPE	CONFIGURATION	WIPES/PK	PKS/CS
DCVPH3012	POINT-OF-USE SATURATED WIPES - 3% HYDROGEN PEROXIDE WITH DI H2O	MSVP 9" X 9"	J-FOLDED	15	12
DCVPH6012	POINT-OF-USE SATURATED WIPES - 6% HYDROGEN PEROXIDE WITH DI H2O	MSVP 9" X 9"	J-FOLDED	15	12

SODIUM HYPOCHLORITE DUOCLEAN™ 0.525 SODIUM HYPOCHLORITE

ITEM #	DESCRIPTION	WIPER TYPE	CONFIGURATION	WIPES/PK	PKS/CS
DCVPBL0512	POINT-OF-USE SATURATED WIPES - 0.525% SODIUM HYPOCHLORITE WITH DI H2O	MSVP 9" X 9"	J-FOLDED	15	12

FOR MORE INFORMATION VISIT WWW.BERKSHIREDUOCLEAN.COM 2018 © BERKSHIRE CORPORATION. ALL RIGHTS RESERVED.



LOW ENDOTOXIN WIPES

Berkshire's new line of low endotoxin cleanroom wipes have been engineered to meet the specific requirements of the pharmaceutical, healthcare and medical device industries.

What is a pyrogen (endotoxin)?

IEST-RP-CC023.2 defines a pyrogen as "A substance capable of producing fevers. The most common pyrogens are endotoxins, a class of lipopolysaccharides that comprise the outer wall of Gram-negative bacteria and are themselves byproducts of cell metabolism."

Endo - Internal Toxin - Poison

Lipid A is the most toxic component of a gram-negative bacteria. It is embedded internally in the living bacteria.

When bacteria is killed through cleaning, the outer cell wall detritus is released and the dead cell becomes toxic. It needs to be removed from the surface.

What are common sources of endotoxins?

Common sources of endotoxins are water, soil, vegetation, raw materials, poor equipment sanitization and maintenance practices.

What are examples of gram-negative endotoxins?

Burkholderia, Pseudomonas, Ralstonia, Escherichia, Serratia, Stenotrophomonas

How do you test wipers for bacterial endotoxins?

Berkshire uses the LAL – Limulus Amebocyte Lysate test.

FDA Guidance for Industry: Pyrogen and Endotoxins Testing

"For more than 30 years, FDA has accepted the use of Limulus Amoebocyte Lysate LAL test for endotoxins in lieu of the rabbit pyrogens test."

What is the frequency of endotoxin testing?

Berkshire tests each lot for endotoxins.

What are your guaranteed endotoxin limits?

<20 EU/device – <0.5 EU/mL

FDA Guidance for Industry: Pyrogen and Endotoxins Testing

"For medical devices...the limit is 0.5 EU/mL or 20 EU/device for products that directly or indirectly contact the cardiovascular system and lymphatic system"

How is the Water For Injection (WFI) prepared?

The WFI is prepared by a validated aseptic sterile filtration process. This complies with the industry's Sterility Assurance Level (SAL) of 10⁻⁶. The specification for Endotoxin USP is ≤0.25 EU/mL.

PRICING & AVAILABILITY

To learn more about Berkshire's low endotoxin wipes, contact your Technical Sales Representative, call 800-242-7000 or visit www.berkshire.com for a quick online chat.



BERKSHIRE CORPORATION

ITEM NUMBER	PRODUCT/ PACKAGING
Sealed edge, cleanroom laundered, polyester knitted, dry wiper	
MSVP09098LE	MicroSeal® VP – 9x9" (23x23cm) 150 SHTS /PK, 8 PKS/CS
MSSS09098LE	MicroSeal SuperSorb® – 9x9" (23x23cm) 100 SHTS /PK, 8 PKS/CS

Sterile, sealed edge, cleanroom laundered, polyester knitted, dry wiper	
GWSSST16LE	Gamma® Wipe SuperSorb® – 12x12" (30x30cm), 10 SHTS /PK, 16 PKS/CS
GWVPST25LE	Gamma Wipe® VP – 12x12" (30x30cm) 20 SHTS /PK, 25 PKS/CS

Sealed edge, cleanroom laundered, polyester knitted, presaturated WFI wiper	
SPXVP00112LE	SatPax® MSVP – 9x9" (23x23cm) 30 SHTS /PK, 12 PKS/CS

Sterile, sealed edge, cleanroom laundered, polyester knitted, presaturated WFI wiper	
SSPVP00112LE	Sterile SatPax® MSVP – 9x9" (23x23cm) 30 SHTS /PK, 12 PKS/CS

Nonwoven, dry wiper	
MFLP090912LE	MicroFirst® LP – 9x9" (23x23cm) 150 SHTS /PK, 12 PKS/CS

Sterile, Nonwoven, dry wiper	
GWMFLPST25LE	Gamma Wipe® MFLP – 12x12" (30x30cm) 20 SHTS /PK, 25 PKS/CS

Nonwoven, presaturated WFI wiper	
SPXMFLP00112LE	SatPax® MFLP – 9x9" (23x23cm) 75 SHTS /PK, 12 PKS/CS
SPX55000624LE	SatPax® 550 – 9x11" (23x28cm) 50 SHTS /PK, 24 PKS/CS

Sterile, nonwoven, presaturated WFI wiper	
SSPMFLP00124LE	Sterile SatPax® MFLP – 9x9" (23x23cm) 30 SHTS /PK, 24 PKS/CS
SSP55000524LE	Sterile SatPax® 550 – 9x11" (23x28cm) 50 SHTS /PK, 24 PKS/CS

VERSAHOCI™ ONE STEP CLEANER AND DISINFECTANT



Stabilized 0.065% Hypochlorous Acid



KILLS 99.99% OF BACTERIA, VIRUSES AND FUNGI
EPA approved List N - SARS-CoV-2 & variants
EPA approved List Q - Monkeypox Virus

VersaHOCI™ is an EPA registered, RTU (ready to use) one-step cleaner, disinfectant, and deodorizer. Made in the USA with no preservatives or fragrances, Berkshire's VersaHOCI™ is a powerful and safer disinfectant alternative for cleaning and disinfecting needs. Non-toxic with low odor and low residue, VersaHOCI™ establishes the safest standards in disinfectant technology. With an active ingredient of 0.065% hypochlorous acid, it's non-corrosive and effective on hard, non-porous surfaces. This versatile disinfectant is ideal for use in controlled environments such as labs, cleanrooms, compounding pharmacies, and manufacturing facilities and can also be used in areas such as hospitals, clinics, healthcare facilities, schools, and government and office buildings.

FEATURES	BENEFITS
Kills 99.99% of bacteria, viruses, and fungi	• Kills common microbiological contaminations on surfaces
Contains no quaternary ammonium, surfactant, alcohols, or organic solvents	• Very low residue, saving time on residue removal
No hazard classification	• Wide range of material compatibility
Bottles individually bagged	• No strong odor provides good user acceptability
Not classed as corrosive	• No special disposal is required
Ready to Use	• Facilitates transfer disinfection into cleanroom
	• Can be used safely on all hard, non-porous surfaces
	• No mixing required

H2O2 VS. HOCl



DISINFECTANT COMPARISON CHART

VERSAHOCI™ A SAFER DISINFECTANT

VERSAHOCI™ ONE STEP CLEANER AND DISINFECTANT

ORGANISM	IDENTITY	CONTACT TIME
Bactericidal		
<i>Pseudomonas aeruginosa</i>	ATCC 15442	5 minutes
<i>Staphylococcus aureus</i>	ATCC 6358	5 minutes
Fungicidal		
<i>Trichophyton interdigitale</i>	ATCC 9533	10 minutes
Virucidal		
Human Adenovirus Type 5	ATCC VR-5, Strain Adenoid 75	5 minutes
Human Coronavirus	ATCC VR-740	5 minutes
Rhinovirus Type 37	ATCC VR-1607, Strain 151-1	10 minutes

All organisms are tested with EPA-approved, standardized tests, demonstrating at least 4-log reduction.

Product Application

- Controlled environments and general institutional/industrial cleaning: Broad-spectrum efficacy (bacteria, viruses, fungi) and one-step cleaner and disinfectant.
- Reduce safety concerns in controlled environments: low residue product.
- Sensitive surfaces and equipment: Good surface compatibility offers versatility and is not damaging.
- Healthcare and long-term care facilities: One step, ready to use effectively and efficiently clean and disinfect near-patient surfaces and equipment.
- Hospitality and school environments: No harsh chemicals, toxins, or added fragrances provide flexibility for use.

Order Information

Product	Number	Size (Net Contents)	Style	Bottles/Case
VersaHOCI™	VHOCL12Q	32 Fl. Oz. (946mL)	Bottle w/trigger sprayer	12
VersaHOCI™	VHOCL1	32 Fl. Oz. (946mL)	Bottle w/trigger sprayer	1



RECOMMENDED WIPES TO USE WITH THIS PRODUCT:

PRODUCT

[Pro-Wipe® SuperSorb](#)

[Durx® 670](#)

[Durx® 770](#)

[Polx® Nonwoven](#)

[ValuClean® Plus](#)

[MicroSeal® - VP](#)

HOCI has been evaluated by regulatory agencies, healthcare institutions, professional organizations, independent laboratories, and academic institutions in more than 50 countries. It is cleared as a high-level disinfectant by the FDA and the USDA allows it in organic production and handling.

ORDER HERE



EZ BLEACH™ DISINFECTANT TABLETS

Berkshire
ENGINEERED CLEAN

EPA REGISTERED



KILLS
99.999%
OF GERMS



LESS
PACKAGING
WASTE



pH NEUTRAL:
GENTLE ON
SURFACES



NO HARSH
FUMES

NaDCC - Each rapidly dissolving 48.21% sodium dichloro-s-triazinetrione tablet is the equivalent of 29% available chlorine, a broad spectrum and sporicidal disinfectant. 1 tub of 900 (5g) tablets will produce 180 gallons of liquid bleach.

ADVANTAGES

- No harsh fumes for the end user
- Less corrosive to surfaces compared to liquid bleach
- Neutral and consistent pH levels
- Made in the USA and EPA registered
- Tablets have a 3 year shelf life
- Flexibility - Easily control the level of dilution to match your specific disinfectant requirements.
- Safe & convenient - No handling or measuring concentrated hazardous liquids

RESULTS

- Kills C. difficile spores in 10 minutes
- 99.9% effective against respiratory syncytial viruses and influenza H1N1 (colds and flu)
- Better than liquid bleach:
 - more sustainable
 - easier to handle and store
 - stable formulation
- Use as a sanitizer, broad-spectrum disinfectant and/or sporicide

APPLICATIONS

- A replacement for liquid bleach solutions
- Chemically compatible with Berkshire cleanroom wipes

EPA List N approved - meets the EPA's criteria for use against SARS-CoV-2, the virus that causes COVID-19.

TABLET GUIDE FOR SPORICIDE (1988PPM)

16 oz
1 TABLET



32 oz
2 TABLETS



1 GAL
5.25 TABLETS



ORDER INFORMATION

SKU	PRODUCT	PACKAGING
EZBDT101	EZ BLEACH DISINFECTANT TABLETS	900 TABLETS PER TUB*

* Approximate count



**MADE
IN USA**

EZ BLEACH™

Bactericidal & sporicidal bleach alternative disinfectant in an effervescent tablet form



EZ Bleach™ is a solid-form, safer alternative to traditional bleach that is EPA-registered and included on List N, the EPA's index of products certified for use against SARS-CoV-2, the virus responsible for COVID-19. EZ Bleach™ comes in an easy-to-use 5g tablet. When mixed in water, the effervescent tablet activates and develops into a solution of hypochlorous acid (HOCl), a chlorine disinfectant much more potent than traditional liquid bleach. The unique delivery of EZ Bleach™ allows for the precise preparation of various concentrations as needed for the intended application. The tablet form and its unique chemical composition, made up of NaDCC (sodium dichloro-s-triazinetriene) ensure a shelf-stability of three years, nearly triple that of traditional bleach products.

Attribute	EZ Bleach™	Similar Tablet 1	Similar Tablet 2
EPA Registered	Yes	Yes	Yes
Active Ingredients	Sodium dichloro-s-triazinetriene (NaDCC) 48.21%	Sodium dichloro-s-triazinetriene (NaDCC) 48.21%	Sodium dichloro-s-triazinetriene (NaDCC) 48.21%
Shelf-Life	3 years	3 years	3 years
Tablet Size	5 g	13.1 g	13.1 g
Efficacy Claims			
Sanitizer	1 minute, 3 organisms	1 minute, 3 organisms	1 minute, 3 organisms
Bactericidal Disinfection	10 minutes, 14 organisms	4 or 10 minutes, 14 organisms	4 or 10 minutes, 14 organisms
Virucidal Disinfection	10 minutes, 11 organisms	1,2,4, or 10 minutes, 13 organisms	1,2,4, or 10 minutes, 13 organisms
Mycobactericidal (TB) Disinfection	N/A	4 minutes	4 minutes
Fungicidal Disinfection	10 minutes, 1 organism	1,2,4, or 10 minutes, 10 organisms	1,2,4, or 10 minutes, 10 organisms
Sporicidal	10 minutes	4 or 10 minutes	4 or 10 minutes
Animal pathogens	10 or 30 minutes, 15 organisms	10 or 30 minutes, 13 organisms	10 or 30 minutes, 13 organisms
List N (SARS-CoV-2 virus)	Yes	Yes	Yes
List Q (Mpox Virus)	Yes	Yes	Yes
List K (Clostridium difficile Spores)	Yes	Yes	Yes
Electrostatic Sprayer Usage	Limited*	Approved	Approved

*Test before using

Do you have questions or want to learn more about EZ Bleach™?

Berkshire's team of Technical Account Managers are well trained and deeply knowledgeable about contamination control and cleanroom supplies. And they are ready to help guide you in your product selection. To locate and contact your representative today, please visit <https://berkshire.com/support/customer-service/find-a-technical-account-manager/>.

For additional technical data specifications about EZ Bleach™, please visit www.berkshire.com to view and download our Product Information Sheet.



CONTAMINATION CONTROL PRODUCT CATALOG